

# Environmental Sensing Profile (ESP)

## **Bluetooth® Test Suite**

---

- **Revision:** ESP.TS.p6
- **Revision Date:** 2024-10-08
- **Prepared By:** BTI
- **Published during TCRL:** TCRL.2024-2-addition



This document, regardless of its title or content, is not a Bluetooth Specification as defined in the Bluetooth Patent/Copyright License Agreement (“PCLA”) and Bluetooth Trademark License Agreement. Use of this document by members of Bluetooth SIG is governed by the membership and other related agreements between Bluetooth SIG Inc. (“Bluetooth SIG”) and its members, including the PCLA and other agreements posted on Bluetooth SIG’s website located at [www.bluetooth.com](http://www.bluetooth.com).

THIS DOCUMENT IS PROVIDED “AS IS” AND BLUETOOTH SIG, ITS MEMBERS, AND THEIR AFFILIATES MAKE NO REPRESENTATIONS OR WARRANTIES AND DISCLAIM ALL WARRANTIES, EXPRESS OR IMPLIED, INCLUDING ANY WARRANTY OF MERCHANTABILITY, TITLE, NON-INFRINGEMENT, FITNESS FOR ANY PARTICULAR PURPOSE, THAT THE CONTENT OF THIS DOCUMENT IS FREE OF ERRORS.

TO THE EXTENT NOT PROHIBITED BY LAW, BLUETOOTH SIG, ITS MEMBERS, AND THEIR AFFILIATES DISCLAIM ALL LIABILITY ARISING OUT OF OR RELATING TO USE OF THIS DOCUMENT AND ANY INFORMATION CONTAINED IN THIS DOCUMENT, INCLUDING LOST REVENUE, PROFITS, DATA OR PROGRAMS, OR BUSINESS INTERRUPTION, OR FOR SPECIAL, INDIRECT, CONSEQUENTIAL, INCIDENTAL OR PUNITIVE DAMAGES, HOWEVER CAUSED AND REGARDLESS OF THE THEORY OF LIABILITY, AND EVEN IF BLUETOOTH SIG, ITS MEMBERS, OR THEIR AFFILIATES HAVE BEEN ADVISED OF THE POSSIBILITY OF SUCH DAMAGES.

This document is proprietary to Bluetooth SIG. This document may contain or cover subject matter that is intellectual property of Bluetooth SIG and its members. The furnishing of this document does not grant any license to any intellectual property of Bluetooth SIG or its members.

This document is subject to change without notice.

Copyright © 2013–2024 by Bluetooth SIG, Inc. The Bluetooth word mark and logos are owned by Bluetooth SIG, Inc. Other third-party brands and names are the property of their respective owners.



# Contents

<b>1</b>	<b>Scope</b>	<b>5</b>
<b>2</b>	<b>References, definitions, and abbreviations</b>	<b>6</b>
2.1	References	6
2.2	Definitions	6
2.3	Acronyms and abbreviations	6
<b>3</b>	<b>Test Suite Structure (TSS)</b>	<b>7</b>
3.1	Overview	7
3.2	Test Strategy	7
3.2.1	Test database requirements	8
3.3	Test groups	8
<b>4</b>	<b>Test cases (TC)</b>	<b>9</b>
4.1	Introduction	9
4.1.1	Test case identification conventions	9
4.1.2	Conformance	9
4.1.3	Pass/Fail verdict conventions	10
4.2	Setup preambles	10
4.2.1	ATT Bearer on LE Transport	10
4.2.2	ATT Bearer on BR/EDR Transport	10
4.2.3	LE Collector: Scan to detect Sensor Connectable Advertisements and initiate a connection	11
4.2.4	BR/EDR Collector	12
4.3	Generic GATT Integrated Tests	13
	ESP/COL/CGGIT/SER/BV-01-C [Service GGIT – Environmental Sensing Service]	13
	ESP/COL/CGGIT/SER/BV-02-C [Service GGIT – Device Information Service]	13
	ESP/COL/CGGIT/SER/BV-03-C [Service GGIT – Battery Service]	13
	ESP/COL/CGGIT/CHA/BV-01-C [Characteristic GGIT – Descriptor Value Changed]	13
	ESP/COL/CGGIT/CHA/BV-02-C [Characteristic GGIT - Battery Level]	13
	ESP/SEN/SGGIT/SDPNF/BV-01-C [Not discoverable over BR/EDR - Environmental Sensing Service]	13
4.4	Discover Services, Characteristics and Characteristic Descriptors	14
	ESP/COL/ESD/BV-06-C [Discover ESS Characteristic]	14
	ESP/COL/ESD/BV-07-C [Discover ESS Characteristic – Characteristic Descriptors]	15
	ESP/COL/ESD/BV-10-C [Discover Device Information Service Characteristics]	16
4.5	Read Characteristics and Characteristic Descriptors	17
	ESP/COL/ESR/BV-01-C [Read ESS Characteristic]	17
	ESP/COL/ESR/BV-02-C [Read ES Measurement Descriptor]	18
	ESP/COL/ESR/BV-03-C [Read ES Trigger Setting Descriptor]	19
	ESP/COL/ESR/BV-04-C [Read ES Configuration Descriptor]	20
	ESP/COL/ESR/BV-05-C [Read Characteristic User Description Descriptor]	22
	ESP/COL/ESR/BV-06-C [Read Long Characteristic User Description Descriptor]	23
	ESP/COL/ESR/BV-07-C [Read Valid Range Descriptor]	24
	ESP/COL/ESR/BV-08-C [Read Device Information Service Characteristics]	25
4.6	Write Characteristics and Characteristic Descriptors	26
	ESP/COL/ESW/BV-01-C [Write ES Trigger Setting Descriptor]	26
	ESP/COL/ESW/BV-02-C [Write ES Configuration Descriptor]	27
	ESP/COL/ESW/BV-03-C [Write Characteristic User Description Descriptor]	28
	ESP/COL/ESW/BV-04-C [Write Long Characteristic User Description Descriptor]	29
4.7	Environmental Sensing Features	30
	ESP/SEN/ESF/BV-01-C [Environmental Sensing Service UUID in AD]	30
	ESP/SEN/ESF/BV-02-C [Local Name included in AD or Scan Response]	31



---

ESP/SEN/ESF/BV-03-C [Appearance included in AD or Scan Response] .....	32
ESP/SEN/ESF/BV-04-C [Service Data included in AD] .....	33
ESP/COL/ESF/BV-05-C [Configure ESS Characteristic for Notification] .....	34
ESP/COL/ESF/BV-06-C [Receive ESS Characteristic Notifications] .....	34
ESP/COL/ESF/BV-07-C [Configure Descriptor Value Changed for Indication] .....	35
ESP/COL/ESF/BV-08-C [Receive Descriptor Value Changed Indications] .....	36
ESP/COL/ESF/BV-09-C [Configure a Battery Level Characteristic for Notification] .....	38
ESP/COL/ESF/BV-10-C [Receive Battery Level Characteristic Notifications] .....	39
ESP/SEN/ESF/BV-11-C [Send ESS Characteristic Notifications – Change Index Update] .....	40
ESP/COL/ESF/BV-12-C [Receive ESS Characteristic Notifications – Change Index Filtering] .....	41
4.8 Service Procedures – General Error Handling .....	42
ESP/COL/SPE/BI-01-C [Application Error Handling – Condition Not Supported] .....	42
<b>5 Test case mapping .....</b>	<b>44</b>
<b>6 Revision history and acknowledgments .....</b>	<b>46</b>

# 1 Scope

---

This Bluetooth document contains the Test Suite Structure (TSS) and test cases to test the implementation of the Bluetooth Environmental Sensing Profile Specification with the objective to provide a high probability of air interface interoperability between the tested implementation and other manufacturers' Bluetooth devices.

## 2 References, definitions, and abbreviations

### 2.1 References

This document incorporates provisions from other publications by dated or undated reference. These references are cited at the appropriate places in the text, and the publications are listed hereinafter. Additional definitions and abbreviations can be found in [1], [2], and [6].

- [1] Test Strategy and Terminology Overview
- [2] Bluetooth Core Specification, Version 4.0 or later
- [3] Environmental Sensing Profile Specification, Version 1.0
- [4] ICS Proforma for Environmental Sensing Profile, ESP.ICS
- [5] GATT Test Suite, GATT.TS
- [6] Environmental Sensing Service Specification, Version 1.0
- [7] Environmental Sensing Service Test Suite, ESS.TS
- [8] Device Information Service Specification, Version 1.1
- [9] Battery Service Specification, Version 1.0
- [10] Characteristic and Descriptor descriptions are accessible via the [Bluetooth SIG Assigned Numbers](#)
- [11] ICS Proforma for Environmental Sensing Service, ESS.ICS
- [12] Environmental Sensing Profile Implementation eXtra Information for Test, IXIT

### 2.2 Definitions

In this Bluetooth document, the definitions from [1], [2], and [6] apply.

### 2.3 Acronyms and abbreviations

In this Bluetooth document, the definitions, acronyms, and abbreviations from [1], [2], and [6] apply.

Acronyms and abbreviations	Definition
ES	Environmental Sensing
ESS	Environmental Sensing Service

Table 2.1: Acronyms and abbreviations

### 3 Test Suite Structure (TSS)

#### 3.1 Overview

The Environmental Sensing Profile requires the presence of GAP, ATT, and GATT. Where the LE transport is used, SM is also required. Where the BR/EDR transport is used, SDP is also required. This is illustrated in Figure 3.1.

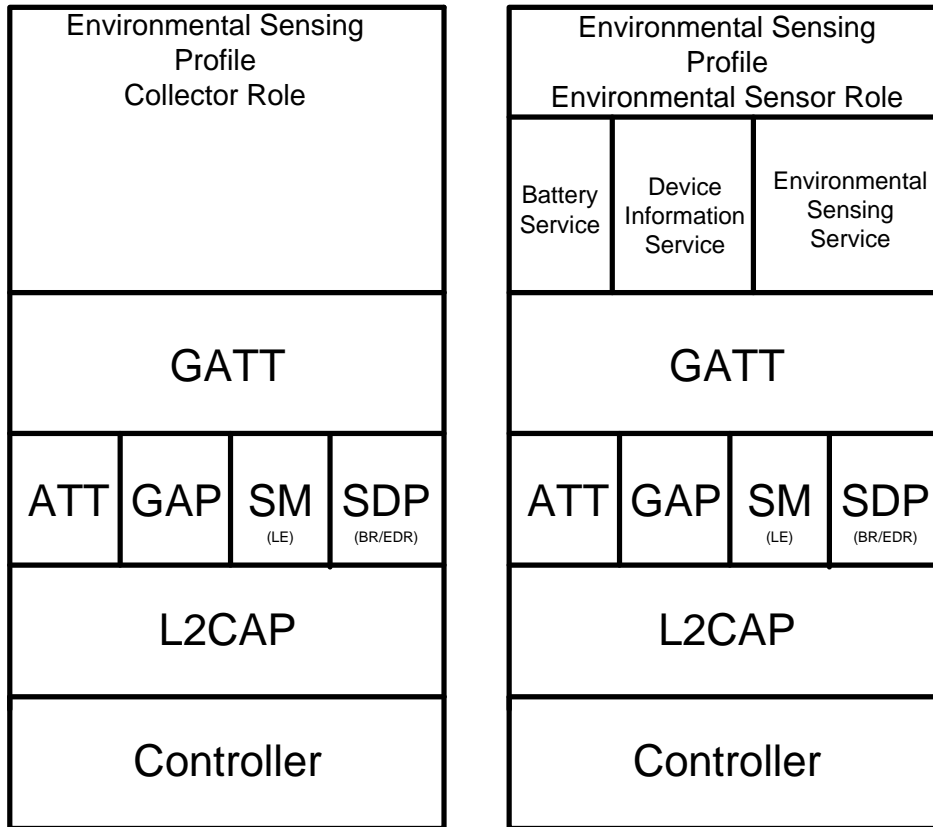

Figure 3.1: Environmental Sensing test model

Supporting the Battery Service and Device Information Service is optional for the Collector and for the Environmental Sensor.

#### 3.2 Test Strategy

The test objectives are to verify the functionality of the Environmental Sensing Profile within a Bluetooth Host and enable interoperability between Bluetooth Hosts on different devices. The testing approach covers mandatory and optional requirements in the specification and matches these to the support of the IUT as described in the ICS. Any defined test herein is applicable to the IUT if the ICS logical expression defined in the Test Case Mapping Table (TCMT) evaluates to true.

The test equipment provides an implementation of the Radio Controller and the parts of the Host needed to perform the test cases defined in this Test Suite. A Lower Tester acts as the IUT’s peer device and interacts with the IUT over-the-air interface. The configuration, including the IUT, needs to implement similar capabilities to communicate with the test equipment. For some test cases, it is necessary to stimulate the IUT from an Upper Tester. In practice, this could be implemented as a special test interface, a Man Machine Interface (MMI), or another interface supported by the IUT.

This Test Suite contains Valid Behavior (BV) tests complemented with Invalid Behavior (BI) tests where required. The test coverage mirrored in the Test Suite Structure is the result of a process that started with catalogued specification requirements that were logically grouped and assessed for testability enabling coverage in defined test purposes.

### 3.2.1 Test database requirements

The following requirements apply to the set of databases used by the Lower Tester for testing of GATT Client functionality:

- The Lower Tester includes one instantiation of each of the services used by this profile including all defined characteristics.
- Each service instantiation also contains two «future» characteristics.
  - If possible, with one inserted before the first characteristic defined
  - If possible, with one appended after the last characteristic defined
- Each «future» characteristic has a 16-bit UUID randomly selected from unassigned UUIDs at the time of the test.

### 3.3 Test groups

The following test groups have been defined:

- Generic GATT Integrated Tests
- Discovery of Services, Characteristics and Characteristic Descriptors
- Read Characteristics and Characteristic Descriptors
- Write Characteristics and Characteristic Descriptors
- Environmental Sensing Features
- Service Procedures



## 4 Test cases (TC)

### 4.1 Introduction

#### 4.1.1 Test case identification conventions

Test cases are assigned unique identifiers per the conventions in [1]. The convention used here is: **<spec abbreviation>/<IUT role>/<class>/<feat>/<func>/<subfunc>/<cap>/<xx>-<nn>-<y>**.

Additionally, testing of this specification includes tests from the GATT Test Suite [5] referred to as Generic GATT Integrated Tests (GGIT); when used, the test cases in GGIT are referred to through a TCID string using the following convention:

**<spec abbreviation>/<IUT role>/<GGIT test group>/< GGIT class >/<xx>-<nn>-<y>**.

Identifier Abbreviation	Spec Identifier <spec abbreviation>
ESP	Environmental Sensing Profile
Identifier Abbreviation	Role Identifier <IUT role>
COL	Collector Role
SEN	Environmental Sensor Role
Identifier Abbreviation	Reference Identifier <GGIT test group>
CGGIT	Client Generic GATT Integrated Tests
SGGIT	Server Generic GATT Integrated Tests
Identifier Abbreviation	Reference Identifier <GGIT class>
CHA	Characteristic
SDPNF	SDP Record Not Found
SER	Service
Identifier Abbreviation	Feature Identifier <feat>
ESD	Discovery of Services, Characteristics and Characteristic Descriptors
ESF	Environmental Sensing Features
ESR	Reading of Characteristics and Characteristic Descriptors
ESW	Writing of Characteristics and Characteristic Descriptors
SEN	Environmental Sensor Role
SPE	Service Procedure – Error Handling

Table 4.1: ESP TC feature naming conventions

#### 4.1.2 Conformance

When conformance is claimed for a particular specification, all capabilities are to be supported in the specified manner. The mandated tests from this Test Suite depend on the capabilities to which conformance is claimed.

The Bluetooth Qualification Program may employ tests to verify implementation robustness. The level of implementation robustness that is verified varies from one specification to another and may be revised for cause based on interoperability issues found in the market.

Such tests may verify:

- That claimed capabilities may be used in any order and any number of repetitions not excluded by the specification
- That capabilities enabled by the implementations are sustained over durations expected by the use case
- That the implementation gracefully handles any quantity of data expected by the use case
- That in cases where more than one valid interpretation of the specification exists, the implementation complies with at least one interpretation and gracefully handles other interpretations
- That the implementation is immune to attempted security exploits

A single execution of each of the required tests is required to constitute a Pass verdict. However, it is noted that to provide a foundation for interoperability, it is necessary that a qualified implementation consistently and repeatedly pass any of the applicable tests.

In any case, where a member finds an issue with the test plan generated by the Bluetooth SIG qualification tool, with the test case as described in the Test Suite, or with the test system utilized, the member is required to notify the responsible party via an erratum request such that the issue may be addressed.

### 4.1.3 Pass/Fail verdict conventions

Each test case has an Expected Outcome section. The IUT is granted the Pass verdict when all the detailed pass criteria conditions within the Expected Outcome section are met.

The convention in this Test Suite is that, unless there is a specific set of fail conditions outlined in the test case, the IUT fails the test case as soon as one of the pass criteria conditions cannot be met. If this occurs, then the outcome of the test is a Fail verdict.

## 4.2 Setup preambles

The procedures defined in this section are used to achieve specific conditions on the IUT and the test equipment within the tests defined in this document. The preambles here are commonly used to establish initial conditions.

### 4.2.1 ATT Bearer on LE Transport

- Preamble Procedure
  1. Establish an LE transport connection between the IUT and the Lower Tester.
  2. Establish an L2CAP channel 0x0004 between the IUT and the Lower Tester over that LE transport.

### 4.2.2 ATT Bearer on BR/EDR Transport

- Preamble Procedure
  1. Establish a BR/EDR transport connection between the IUT and the Lower Tester.
  2. Establish several L2CAP channels (PSM 0x001F) between the IUT and the Lower Tester over that BR/EDR transport.



### 4.2.3 LE Collector: Scan to detect Sensor Connectable Advertisements and initiate a connection

- Preamble Purpose

This LE preamble procedure specifies how the Collector IUT scans for Environmental Sensor connectable advertisements.

- Reference

[3] 5.2

[2] GAP 9.3.3 and GAP 9.3.4

- Preamble Procedure

- Configure the Collector IUT to accept commands from the Upper Tester to receive data from the Environmental Sensor (Lower Tester).
- The Upper Tester commands the Collector IUT to initiate a connection and the IUT starts scanning.
- The Environmental Sensor (Lower Tester) advertises to the Collector IUT either using:
  - ALT 1: GAP Directed Connectable Mode (send ADV\_DIRECT\_IND packets), if receipt of directed advertising is supported by the Collector IUT,
 or
  - ALT 2: GAP Undirected Connectable Mode (send ADV\_IND packets).
- The Lower Tester waits for responses from the Collector IUT.
- The Collector IUT sends a CONNECT\_REQ and an optionally empty PDU to the Lower Tester.

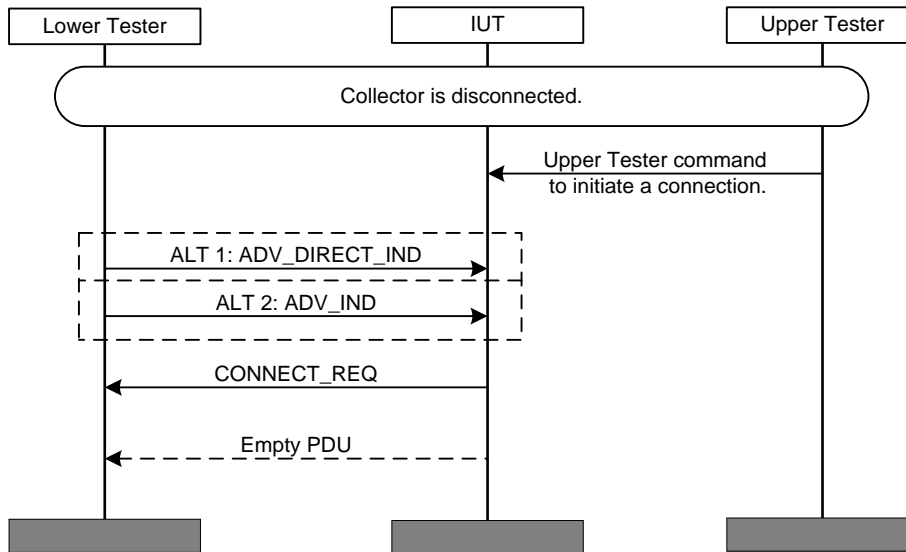

Figure 4.1: LE Collector: Scan to detect Sensor Connectable Advertisements and initiate a connection

## 4.2.4 BR/EDR Collector

### 4.2.4.1 Unbonded Devices

- Preamble Purpose

This BR/EDR preamble procedure specifies how the Collector IUT scans for the Environmental Sensor.

- Reference

[3] 5.3

[2] GAP 4.1 and GAP 4.2

- Preamble Procedure

1. Configure the Collector IUT to accept commands to receive data from the Environmental Sensor (Lower Tester).
2. Put the Environmental Sensor in General Discoverable or Limited Discoverable mode.
3. The Upper Tester commands the Collector IUT to initiate a connection and the IUT starts scanning.
4. The Environmental Sensor (Lower Tester) exposes the SDP record for the Environmental Sensing Service.
5. The Collector IUT validates the SDP record and establishes a connection to the Environmental Sensor.
6. The Collector IUT uses the GAP General Discovery or GAP Limited Discovery procedure to discover and establish a connection to an Environmental Sensor.

### 4.2.4.2 Bonded Devices

- Preamble Purpose

In case of BR/EDR, either an Environmental Sensor or Collector could initiate connection when they are bonded. The device initiating the connection becomes a Central and is referred to here as the “paging device”. The device accepting the connection becomes a Peripheral and is referred to here as the “page scanning device”.

This BR/EDR preamble procedure specifies how a paging device connects to a page scanning device.

- Reference

[3] 5.3

[2] GAP 4.1 and GAP 4.2

- Preamble Procedure

1. Configure the Collector IUT to accept commands to receive data from the Environmental Sensor (Lower Tester).
2. Put the page scanning device in connectable mode to accept a connection from the paging device.
3. The connection is initiated by the paging device.
4. The Peripheral exposes the SDP record for the Environmental Sensing Service.
5. The Central validates the SDP record and establishes a connection to the Peripheral.
6. The Central uses the GAP Link Establishment Procedure to connect to any bonded device.

### 4.3 Generic GATT Integrated Tests

Execute the Generic GATT Integrated Tests defined in [5] Section 6.3, Server test procedures (SGGIT), and Section 6.4, Client Test Procedures (CGGIT), using Table 4.2 as input:

TCID	Service / Characteristic / Descriptor	Reference	Properties	Value Length (Octets)	Service Type
ESP/COL/CGGIT/SER/BV-01-C [Service GGIT – Environmental Sensing Service]	Environmental Sensing Service	[3] 4, 5.3	-	-	Primary Service
ESP/COL/CGGIT/SER/BV-02-C [Service GGIT – Device Information Service]	Device Information Service	[3] 4, 5.3	-	-	Primary Service
ESP/COL/CGGIT/SER/BV-03-C [Service GGIT – Battery Service]	Battery Service	[3] 4, 5.3	-	-	Primary Service
ESP/COL/CGGIT/CHA/BV-01-C [Characteristic GGIT – Descriptor Value Changed]	Descriptor Value Changed Characteristic	[3] 4.5	0x20 (Indicate)	Skip	-
ESP/COL/CGGIT/CHA/BV-02-C [Characteristic GGIT - Battery Level]	Battery Level Characteristic	[3] 4.8	0x12 (Read, Notify)	1	-
ESP/SEN/SGGIT/SDPNF/BV-01-C [Not discoverable over BR/EDR - Environmental Sensing Service]	Environmental Sensing Service	[3] 2.5, 4.2	-	-	-

Table 4.2: Input for the GGIT Server test procedure



## 4.4 Discover Services, Characteristics and Characteristic Descriptors

The procedures defined in this test group verify the IUT's ability to discover the services, characteristics and characteristic descriptors exposed by an Environmental Sensor (Lower Tester).

### ESP/COL/ESD/BV-06-C [Discover ESS Characteristic]

- Test Purpose

Verify that all ESS Characteristics that are supported by the Collector IUT are discovered.

- Reference

[3] 4.3.1

- Initial Condition

- Establish an ATT Bearer connection between the Lower Tester and IUT, running the preamble procedure for the Collector to initiate connection to an Environmental Sensor as described in Section 4.2.3, if using a LE transport, or Section 4.2.4 if using a BR/EDR transport.
- The Lower Tester includes one instantiation of the Environmental Sensing Service [6] including all defined characteristics.
- There are at least two instances of an ESS Characteristic with the same UUID. The UUID of the ESS Characteristic of which multiple instances are exposed is a UUID that is supported by the Collector IUT. Each instance of this ESS Characteristic also has an ES Measurement descriptor associated with it.
- The instances of the ESS Characteristic with the same UUID are distinguishable from each other by means of their ES Measurement descriptors which have different values in at least one field (e.g., the Application field defines one sensor location as 'Upper' (0x0F) and the other as 'Lower' (0x10)).
- The IUT has executed [ESP/COL/CGGIT/SER/BV-01-C \[Service GGIT – Environmental Sensing Service\]](#) procedure and has saved the handle range for an instantiation of the Environmental Sensing Service.

- Test Procedure

1. The Upper Tester issues a command to the IUT to discover ESS Characteristics.
2. The IUT executes either alternative 2A or 2B.

Alternative 2A (Discover All Characteristics of a Service sub-procedure):

2A: Discover All Characteristics of a Service using the specified handle range, with the Lower Tester instantiating the database specified in Section 3.2.1.

Alternative 2B (Discover Characteristics by UUID sub-procedure):

2B: Discover Characteristics by UUID using each of the UUIDs for the characteristics of the Environmental Sensing Service supported by the IUT, with the Lower Tester instantiating the database specified in Section 3.2.1.

- Expected Outcome

Pass verdict

For each instance of the ESS Characteristics exposed by the Lower Tester that is supported by the Collector IUT according to its ICS [4], verify that an Attribute handle/value pair discovered by the IUT contains a valid UUID with the appropriate property and handle.

If the Discover All Characteristics of a Service sub-procedure was used by the IUT, one handle/value pair may also be returned for the Descriptor Value Changed characteristic.

### ESP/COL/ESD/BV-07-C [Discover ESS Characteristic – Characteristic Descriptors]

- Test Purpose

Verify that the Collector IUT can discover the characteristic descriptors associated with an ESS Characteristic.

- Reference

[3] 4.3.1

- Initial Condition

- Establish an ATT Bearer connection between the Lower Tester and IUT, running the preamble procedure for the Collector to initiate connection to an Environmental Sensor as described in Section 4.2.3, if using a LE transport, or Section 4.2.4 if using a BR/EDR transport.
- The Lower Tester includes one instantiation of the Environmental Sensing Service [6] in which at least three ESS Characteristics are exposed. These include two instances of an ESS Characteristic with the same UUID. The UUID of the ESS Characteristic of which multiple instances are exposed is a UUID that is supported by the Collector IUT.
- The Lower Tester exposes all of the following characteristic descriptors for each instance of an ESS Characteristic:
  - One instance of the ES Measurement descriptor
  - One instance of the Client Characteristic Configuration descriptor
  - Three instances of the ES Trigger Setting descriptor
  - One instance of the ES Configuration descriptor
  - One instance of the Characteristic User Description descriptor
  - One instance of the Valid Range descriptor
- The instances of the ESS Characteristic with the same UUID are distinguishable from each other by means of their ES Measurement descriptors which have different values in at least one field (e.g., the Application field defines one sensor location as 'Upper' (0x0F) and the other as 'Lower' (0x10)).
- The IUT has discovered the handle range of each ESS Characteristic.

- Test Procedure

1. The Upper Tester issues a command to the IUT to Discover All Characteristic Descriptors using the handle range of the ESS Characteristic.
2. The IUT executes the GATT Discover All Characteristic Descriptors sub-procedure using the specified handle range, with the server database defined in Initial Condition.



- Expected Outcome

Pass verdict

For each instance of an ESS Characteristic exposed by the Lower Tester that are supported by the Collector IUT according to its ICS [4]:

- One attribute handle/value pair is returned containing the UUID «ES Measurement».
- One attribute handle/value pair is returned containing the UUID «Client Characteristic Configuration», if supported by the Collector IUT.
- Three attribute handle/value pairs are returned containing the UUID «ES Trigger Setting», if supported by the Collector IUT.
- One attribute handle/value pair is returned containing the UUID «ES Configuration», if supported by the Collector IUT.
- One attribute handle/value pair is returned containing the UUID «Characteristic User Description», if supported by the Collector IUT.
- One attribute handle/value pair is returned containing the UUID «Valid Range», if supported by the Collector IUT.

The Collector IUT associates the discovered characteristic descriptors with the correct instance of the ESS Characteristic in every case.

### ESP/COL/ESD/BV-10-C [Discover Device Information Service Characteristics]

- Test Purpose

Verify that a Collector IUT can discover all characteristics of a Device Information Service supported by the IUT.

- Reference

[3] 4.3.2

- Initial Condition

- All characteristics of the Device Information Service supported by the IUT are specified in the IXIT [12].
- Run the preamble procedure to enable the Collector to initiate connection to an Environmental Sensor included in Section 4.2.3, if using an LE transport, or Section 4.2.4 if using a BR/EDR transport.
- The IUT has executed ESP/COL/CGGIT/SER/BV-02-C [Service GGIT – Device Information Service] procedure and has saved the handle range for the instantiation of the Device Information Service contained in the Lower Tester. The Device Information Service contains one or more characteristics.



- Test Procedure
  1. The Upper Tester issues a command to the IUT to discover all characteristics of the Device Information Service supported by the IUT.
  2. The IUT executes either alternative 2A or 2B.
 

Alternative 2A (Discover All Characteristics of a Service sub-procedure):

2A: Discover All Characteristics of a Service using the specified handle range, with the Lower Tester instantiating the database specified in Section 3.2.1.

Alternative 2B (Discover Characteristics by UUID sub-procedure):

2B: Discover Characteristics by UUID using each of the UUIDs for the characteristics of the Device Information Service supported by the IUT, with the Lower Tester instantiating the database specified in Section 3.2.1.
- Expected Outcome
 

Pass verdict

For each characteristic supported by the IUT contained in the Lower Tester's instantiation of the Device Information Service, as specified in the IXML [12], the IUT reports an attribute handle/value pair to the Upper Tester.

## 4.5 Read Characteristics and Characteristic Descriptors

The procedures defined in this test group verify the IUT's ability to read characteristics and characteristic descriptors exposed by an Environmental Sensor (Lower Tester).

### ESP/COL/ESR/BV-01-C [Read ESS Characteristic]

- Test Purpose
 

Verify that the Collector IUT can read the ESS Characteristic from an Environmental Sensor.
- Reference
 

[3] 4.4
- Initial Condition
  - A preamble procedure defined in Section 4.2.3, if using an LE transport, or Section 4.2.4, if using a BR/EDR transport, is used to set up the transport and L2CAP channel and initiate connection to an Environmental Sensor.
  - The Upper Tester knows the handle of an ESS Characteristic contained in the Lower Tester.
- Test Procedure
  1. Send a command from the Upper Tester to request the IUT to read an ESS Characteristic from the Lower Tester e.g., *ESP\_ReadRequest* (handle, value).
  2. After receipt of the expected result by the Lower Tester from the IUT, send an *ATT\_Read\_Response* (0x0B) from the Lower Tester to the IUT containing a defined value of the ESS Characteristic.
  3. Repeat steps 1–2 for each ESS Characteristic supported by the Collector IUT according to its ICS [4].

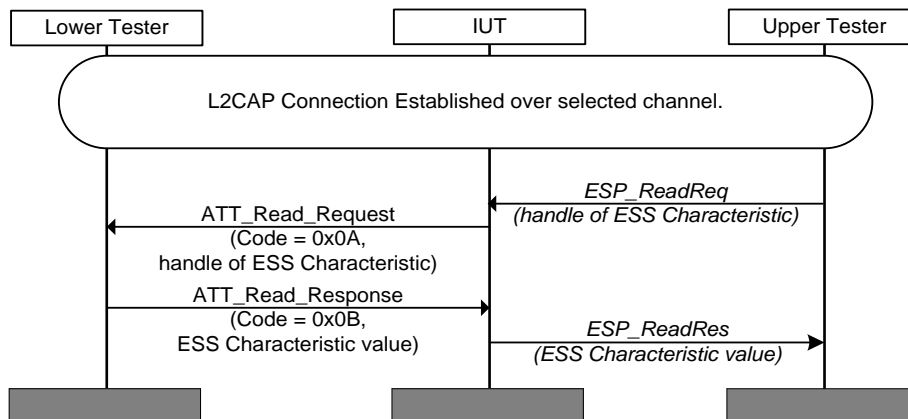

Figure 4.2: ESP/COL/ESR/BV-01-C [Read ESS Characteristic]

- Expected Outcome

Pass verdict

ESS Characteristic supported:

The IUT sends a correctly formatted *ATT\_Read\_Request* (0x0A) to the Lower Tester, containing the handle specified by the Upper Tester.

The IUT receives the response from the Lower Tester and sends the *ESP\_ReadResponse* containing the correct ESS Characteristic value to the Upper Tester.

If measurement units (e.g., kg, meters) are provided by the Collector IUT, these meet the requirements of the service and any scaling factors are correctly applied.

### ESP/COL/ESR/BV-02-C [Read ES Measurement Descriptor]

- Test Purpose

Verify that the Collector IUT can read the ES Measurement descriptor of an ESS Characteristic in an Environmental Sensor.

- Reference

[3] 4.4.1

- Initial Condition

- One of the ESS Characteristics on the Lower Tester supported by the IUT has an ES Measurement descriptor that contains a RFU value in one of its fields (e.g., a RFU bit in the Flags field is set to 1) while the remaining fields contain valid values.
- A preamble procedure defined in Section 4.2.3, if using an LE transport, or Section 4.2.4, if using a BR/EDR transport, is used to set up the transport and L2CAP channel and initiate connection to an Environmental Sensor.
- The Upper Tester knows the handle of an ESS Characteristic and of its ES Measurement descriptor contained in the Lower Tester.

- Test Procedure
  1. Send a command from the Upper Tester to request the IUT to read the ES Measurement descriptor of an ESS Characteristic from the Lower Tester e.g., *ESP\_ReadRequest* (handle, value).
  2. The Lower Tester sends an *ATT\_Read\_Response* (0x0B) to the IUT containing a defined value of the ES Measurement descriptor of the ESS Characteristic.
  3. Repeat steps 1–2 for the ES Measurement descriptor of each ESS Characteristic supported by the Collector IUT according to its ICS [4].

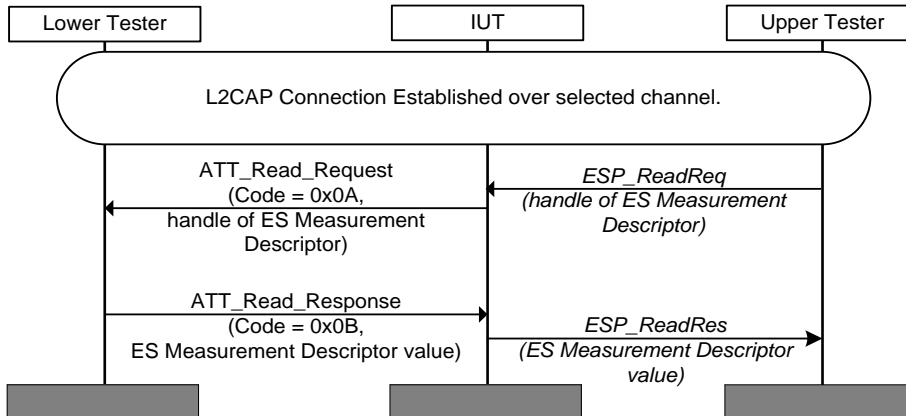

Figure 4.3: ESP/COL/ESR/BV-02-C [Read ES Measurement Descriptor]

- Expected Outcome

Pass verdict

In each round, the IUT sends a correctly formatted *ATT\_Read\_Request* (0x0A) to the Lower Tester, containing the handle specified by the Upper Tester.

In each round, the IUT receives the response from the Lower Tester and sends the *ESP\_ReadResponse* containing the correct ES Measurement descriptor value to the Upper Tester.

The RFU value is ignored and the other fields of the ES Measurement descriptor are read as if the RFU value had been set to 0. It is permissible for the field that contained the RFU value to be reported by the Collector IUT as unspecified or not in use or for the field to be hidden from the user.

### ESP/COL/ESR/BV-03-C [Read ES Trigger Setting Descriptor]

- Test Purpose

Verify that the Collector IUT can read the ES Trigger Setting descriptor(s) of an ESS Characteristic in an Environmental Sensor.

- Reference

[3] 4.4.2

- Initial Condition
  - A preamble procedure defined in Section 4.2.3, if using an LE transport, or Section 4.2.4, if using a BR/EDR transport, is used to set up the transport and L2CAP channel and initiate connection to an Environmental Sensor.
  - The Upper Tester knows the handle of an ESS Characteristic and of three ES Trigger Setting descriptors associated with the ESS Characteristic, contained in the Lower Tester.
  - One of the ESS Characteristics on the Lower Tester supported by the IUT has an ES Trigger Setting descriptor that contains a RFU value in its Condition field. The remaining ES Trigger Setting descriptors contain valid values.
- Test Procedure
  1. Send a command from Upper Tester to request IUT to read an ES Trigger Setting descriptor of an ESS Characteristic from the Lower Tester e.g., *ESP\_ReadRequest* (handle, value).
  2. The Lower Tester sends an *ATT\_Read\_Response* (0x0B) to the IUT containing a defined value of the requested ES Trigger Setting descriptor of the ESS Characteristic.
  3. Repeat steps 1–2 for each ES Trigger Setting descriptor, for each ESS Characteristic supported by the Collector IUT according to its ICS [4].

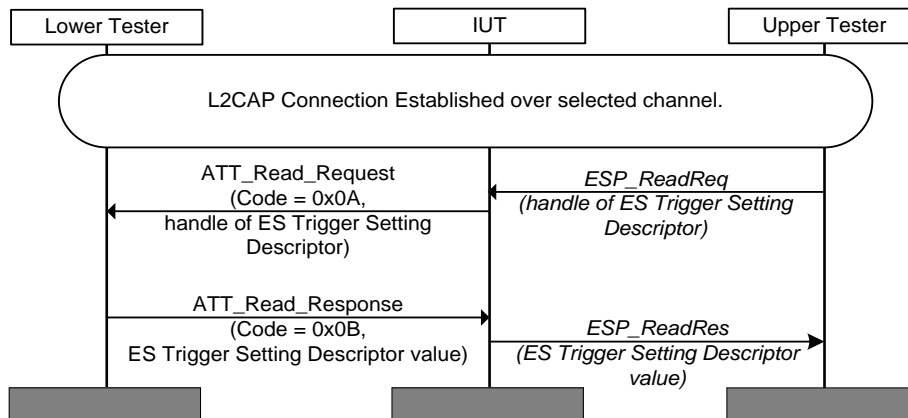

Figure 4.4: ESP/COL/ESR/BV-03-C [Read ES Trigger Setting Descriptor]

- Expected Outcome

Pass verdict

In each round, the IUT sends a correctly formatted *ATT\_Read\_Request* (0x0A) to the Lower Tester, containing the handle specified by the Upper Tester.

In each round, the IUT receives the response from the Lower Tester and sends the *ESP\_ReadResponse* containing the correct ES Trigger Setting descriptor value to the Upper Tester.

The IUT tolerates the RFU value in a manner meeting the requirements of the service and the IUT continues to function normally. The IUT may treat the affected trigger setting information as unavailable due to the presence of the RFU value – this is an acceptable outcome.

### ESP/COL/ESR/BV-04-C [Read ES Configuration Descriptor]

- Test Purpose

Verify that the Collector IUT can read the ES Configuration descriptor of an ESS Characteristic in an Environmental Sensor.

- Reference
  - [3] 4.4.2
- Initial Condition
  - A preamble procedure defined in Section 4.2.3, if using an LE transport, or Section 4.2.4, if using a BR/EDR transport, is used to set up the transport and L2CAP channel and initiate connection to an Environmental Sensor.
  - The Upper Tester knows the handle of an ESS Characteristic and of its ES Configuration descriptor contained in the Lower Tester.
- Test Procedure
  1. Send a command from the Upper Tester to request the IUT to read the ES Configuration descriptor of an ESS Characteristic from the Lower Tester e.g., *ESP\_ReadRequest* (handle, value). The Lower Tester to the IUT containing the value 0x01 (Boolean OR) for the ES Configuration descriptor of the ESS Characteristic.
  2. Verify the value received by the IUT.
  3. Send a command from the Upper Tester to request the IUT to read the same ES Configuration descriptor again from the Lower Tester e.g., *ESP\_ReadRequest* (handle, value).
  4. The Lower Tester sends an *ATT\_Read\_Response* (0x0B) to the IUT containing an RFU value for the ES Configuration descriptor of the ESS Characteristic.
  5. Verify the value received by the IUT.
  6. Repeat steps 1–3 for the ES Configuration descriptor of each ESS Characteristic supported by the Collector IUT according to its ICS [4].

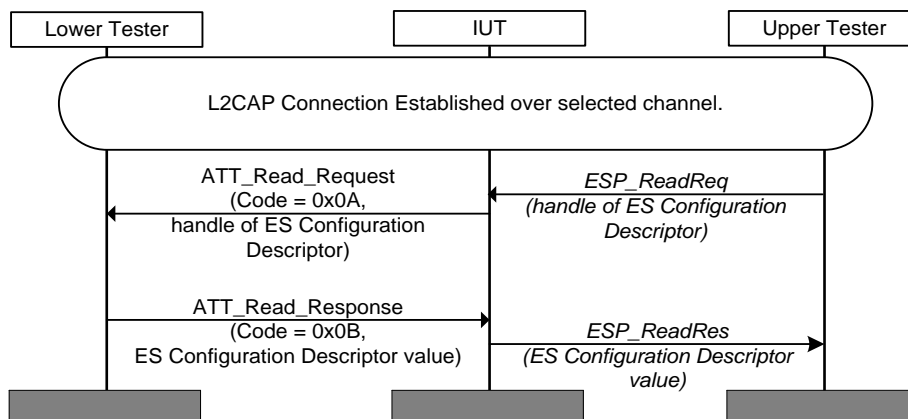

Figure 4.5: ESP/COL/ESR/BV-04-C [Read ES Configuration Descriptor]

- Expected Outcome

#### Pass verdict

For each ESS Characteristic supported:

In step 1 and step 4, the IUT sends a correctly formatted *ATT\_Read\_Request* (0x0A) to the Lower Tester, containing the handle specified by the Upper Tester.

In step 2 and step 5, the IUT receives the response from the Lower Tester and sends the *ESP\_ReadResponse* containing the correct ES Configuration descriptor value to the Upper Tester.

In step 6, the IUT tolerates the RFU value in a manner meeting the requirements of the service and the IUT continues to function normally. The IUT may treat the affected trigger setting information as unavailable in the presence of the RFU value – this is an acceptable outcome.

**ESP/COL/ESR/BV-05-C [Read Characteristic User Description Descriptor]**

- Test Purpose
 

Verify that the Collector IUT can read the Characteristic User Description descriptor(s) of an ESS Characteristic in an Environmental Sensor.
- Reference
 

[3] 4.4.3
- Initial Condition
  - A preamble procedure defined in Section 4.2.3, if using an LE transport, or Section 4.2.4, if using a BR/EDR transport, is used to set up the transport and L2CAP channel and initiate connection to an Environmental Sensor.
  - The Upper Tester knows the handle of an ESS Characteristic and of its Characteristic User Description descriptor contained in the Lower Tester.
  - The length of the Characteristic User Description descriptor value used in this test case is sufficiently short such that its value can be read in its entirety using the GATT Read Characteristic Descriptors sub-procedure when the default ATT\_MTU size is used.
- Test Procedure
  1. Send a command from the Upper Tester to request the IUT to read the Characteristic User Description descriptor of an ESS Characteristic from the Lower Tester e.g., *ESP\_ReadRequest* (handle, value).
  2. The Lower Tester sends an *ATT\_Read\_Response* (0x0B) from the Lower Tester to the IUT containing a defined value of the Characteristic User Description descriptor of the ESS Characteristic.
  3. Repeat steps 1–2 for the Characteristic User Description descriptor of each ESS Characteristic supported by the Collector IUT according to its ICS [4].

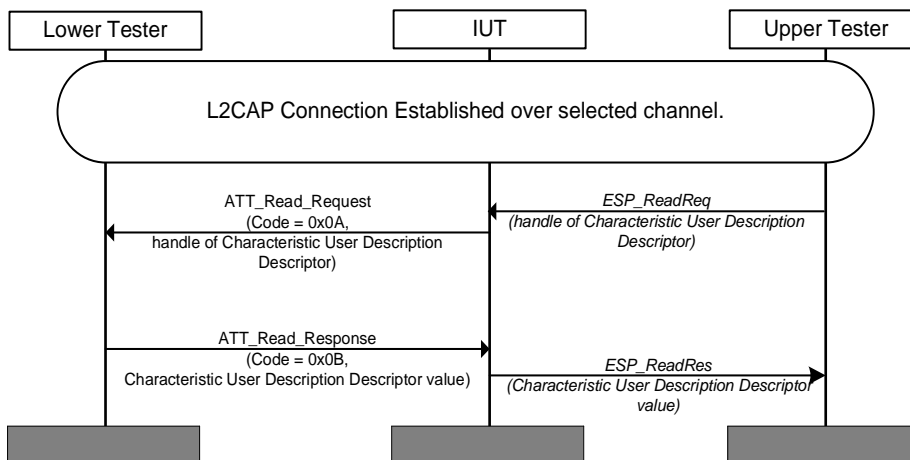

Figure 4.6: ESP/COL/ESR/BV-05-C [Read Characteristic User Description Descriptor]

- Expected Outcome

Pass verdict

For each ESS Characteristic supported:

The IUT sends a correctly formatted *ATT\_Read\_Request* (0x0A) to the Lower Tester, containing the handle specified by the Upper Tester.

The IUT receives the response from the Lower Tester and sends the *ESP\_ReadResponse* containing the correct Characteristic User Description descriptor value to the Upper Tester.

### ESP/COL/ESR/BV-06-C [Read Long Characteristic User Description Descriptor]

- Test Purpose

Verify that the Collector IUT can read the Characteristic User Description descriptor(s) of an ESS Characteristic in an Environmental Sensor when the length of the characteristic descriptor requires the GATT Read Long procedure to be used.

- Reference

[3] 4.4.3

- Initial Condition

- A preamble procedure defined in Section 4.2.3, if using an LE transport, or Section 4.2.4, if using a BR/EDR transport, is used to set up the transport and L2CAP channel and initiate connection to an Environmental Sensor.
- The Upper Tester knows the handle of an ESS Characteristic and of its Characteristic User Description descriptor contained in the Lower Tester.
- For the purposes of this test case, the Lower Tester does not permit an ATT\_MTU size larger than the default ATT\_MTU size for LE to be negotiated.
- The length of the characteristic descriptor used in this test case is sufficiently long such that its value cannot be read in its entirety using the GATT Read Characteristic Descriptors sub-procedure when the default ATT\_MTU size is used, requiring the GATT Read Long Characteristic Descriptors sub-procedure to be used.
- The UTF-8 string value contained in the value of the Characteristic User Description descriptor to be read also includes some character values outside the ASCII printable range.

- Test Procedure

1. Send a command from the Upper Tester to request the IUT to read the Characteristic User Description descriptor of an ESS Characteristic from the Lower Tester.
2. The IUT executes the GATT Read Long Characteristic Descriptors sub-procedure.
3. Note that the first request may be an ATT\_Read Request; in that case the Lower Tester replies with an ATT\_Read\_Response.
4. The IUT detects that the characteristic descriptor is long and sends one or more ATT\_Read\_Blob\_Requests until the IUT determines that it has read the complete characteristic descriptor value.
5. The Lower Tester responds in each ATT transaction as shown in GATT.TS [5] GATT/CL/GAR/BV-07-C [Read Long Characteristic Descriptor - by client].



- Expected Outcome

Pass verdict

The ATT requests sent by the IUT include correctly formatted *ATT\_Read\_Blob\_Requests*, containing the handle specified by the Upper Tester.

The IUT receives the responses from the Lower Tester and sends one *ESP\_ReadResponse* containing the complete Characteristic User Description descriptor value to the Upper Tester.

The IUT reports the Characteristic User Description descriptor value correctly, in its entirety, including all the printable and non-printable ASCII values.

**ESP/COL/ESR/BV-07-C [Read Valid Range Descriptor]**

- Test Purpose

Verify that the Collector IUT can read the Valid Range descriptor(s) of an ESS Characteristic in an Environmental Sensor.

- Reference

[3] 4.4.4

- Initial Condition

- A preamble procedure defined in Section 4.2.3, if using an LE transport, or Section 4.2.4, if using a BR/EDR transport, is used to set up the transport and L2CAP channel and initiate connection to an Environmental Sensor.
- The Upper Tester knows the handle of an ESS Characteristic and of its Valid Range descriptor contained in the Lower Tester.

- Test Procedure

1. Send a command from the Upper Tester to request the IUT to read the Valid Range descriptor of an ESS Characteristic from the Lower Tester e.g., *ESP\_ReadRequest* (handle, value).
2. The Lower Tester sends an *ATT\_Read\_Response* (0x0B) to the IUT containing a defined value of the Valid Range descriptor of the ESS Characteristic.
3. Repeat steps 1–2 for the Characteristic User Description descriptor of each ESS Characteristic supported by the Collector IUT according to its ICS [4].

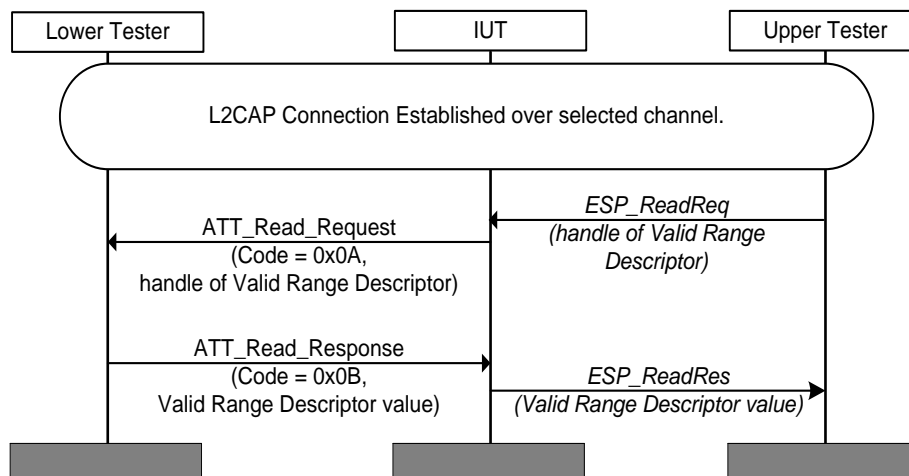

Figure 4.7: ESP/COL/ESR/BV-07-C [Read Valid Range Descriptor]



- Expected Outcome

Pass verdict

For each Valid Range descriptor to be read, the IUT sends a correctly formatted *ATT\_Read\_Request* (0x0A) to the Lower Tester, containing the handle specified by the Upper Tester.

For each request, the IUT receives the response from the Lower Tester and sends the *ESP\_ReadResponse* containing the correct Valid Range descriptor value to the Upper Tester.

### ESP/COL/ESR/BV-08-C [Read Device Information Service Characteristics]

- Test Purpose

Verify that a Collector IUT can read all characteristics of an instantiation of the Device Information Service that are supported by the IUT.

- Reference

[3] 4.7

- Initial Condition

- All characteristics of the Device Information Service supported by the IUT are specified in the IXIT [12].
- Run the preamble procedure for the Collector to initiate connection to an Environmental Sensor included in Section 4.2.3, if using an LE transport, or Section 4.2.4 if using a BR/EDR transport.
- The Lower Tester includes one instantiation of the Device Information Service [8] including all defined characteristics.
- The IUT has previously executed the procedure included in ESP/COL/ESD/BV-10-C [Discover Device Information Service Characteristics], so it has the handle/value pairs for all characteristics of the Device Information Service supported by the IUT.
- For string-based characteristics (i.e., Manufacturer Name String, Model Number String, Serial Number String, Hardware Revision String, Firmware Revision String and Software Revision String), the string initially includes only character values in the ASCII printable range (i.e., 0x20 – 0x7E).
- For the System ID characteristic, the Manufacturer Identifier is set to 0xFFFE9ABCDE and the Organizationally Unique Identifier is set to 0x123456.
- For the IEEE 11073-20601 Regulatory Certification Data List characteristic, the Data field is set to 0x0000-0002-8008-0200-0001-0105-0008-0201-0012-0002.
- For the PnP\_ID characteristic, the Vendor ID Source is set to 0x01, the Vendor ID is set to 0x006B, the Product ID is set to 0x1234 and the Product Version is set to 0x0102.

- Test Procedure

1. The Upper Tester issues a command to the IUT to read all characteristics of the Device Information Service supported by the IUT.
2. For each characteristic of the Device Information Service supported by the IUT, the IUT sends an *ATT\_Read\_Request* to the Lower Tester containing the handle specified by the Upper Tester.
3. The IUT receives an *ATT\_Read\_Response* and reports the value to the Upper Tester.
4. Repeat steps 1–3 with the string-based characteristics changed to include character values outside the ASCII printable range.

- Expected Outcome

#### Pass verdict

For each characteristic contained in the Lower Tester's instantiation of the Device Information Service supported by the IUT, the IUT reports the characteristic value for all characteristics specified in the IXIT [12] to the Upper Tester, including:

- For string-based characteristics, any printable or non-printable ASCII values.
- For System ID characteristic, the Manufacturer Identifier and Organizationally Unique Identifier.
- For the 11073-20601 Regulatory Certification Data List characteristic, the IEEE 11073-20601 regulatory certification data list (note that this value is defined in big endian format).
- For the PnP\_ID characteristic, the Vendor ID Source, the Vendor ID, the Product ID and the Product Version.

## 4.6 Write Characteristics and Characteristic Descriptors

The procedures defined in this test group verify the IUT's ability to write the characteristic descriptors exposed by an Environmental Sensor (Lower Tester).

### ESP/COL/ESW/BV-01-C [Write ES Trigger Setting Descriptor]

- Test Purpose

Verify that the Collector IUT can write one or more ES Trigger Setting descriptors of an ESS Characteristic in an Environmental Sensor.

- Reference

[3] 4.4.2

- Initial Condition

- A preamble procedure defined in Section 4.2.3, if using an LE transport, or Section 4.2.4, if using a BR/EDR transport, is used to set up the transport and L2CAP channel and initiate connection to an Environmental Sensor.
- The Collector IUT and the Lower Tester are bonded.
- The Upper Tester knows the handle of an ESS Characteristic and of its ES Trigger Setting descriptor(s) contained in the Lower Tester.
- The ES Trigger Setting descriptor selected for the test permits writing.

- Test Procedure

1. Send a command from the Upper Tester to request the IUT to write a new value to an ES Trigger Setting descriptor in the Lower Tester e.g., *ESP\_WriteRequest* (handle, value).
2. The Lower Tester sends an *ATT\_Write\_Response* (0x13) to the IUT.

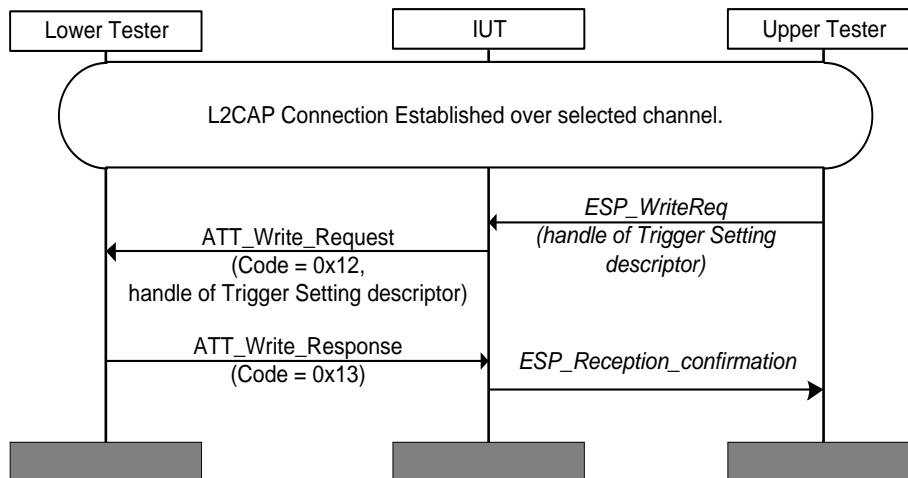

Figure 4.8: ESP/COL/ESW/BV-01-C [Write ES Trigger Setting Descriptor]

- Expected Outcome

Pass verdict

The IUT sends a correctly formatted *ATT\_Write\_Request* (0x12) to the Lower Tester, containing the correct handle and the new value that is to be written as specified by the Upper Tester.

The IUT receives the response from the Lower Tester and sends the *ESP\_WriteResponse* to the Upper Tester.

- Notes

The values that the Collector IUT is able to write to the ES Trigger Setting descriptor(s) depend on the implementation.

### ESP/COL/ESW/BV-02-C [Write ES Configuration Descriptor]

- Test Purpose

Verify that the Collector IUT can write the ES Configuration descriptor of an ESS Characteristic in an Environmental Sensor.

- Reference

[3] 4.4.2

- Initial Condition

- A preamble procedure defined in Section 4.2.3, if using an LE transport, or Section 4.2.4, if using a BR/EDR transport, is used to set up the transport and L2CAP channel and initiate connection to an Environmental Sensor.
- The Collector IUT and the Lower Tester are bonded.
- The Upper Tester knows the handle of an ESS Characteristic and its ES Configuration descriptor contained in the Lower Tester.
- The ES Configuration descriptor selected for the test permits writing.

- Test Procedure
  1. Send a command from the Upper Tester to request the IUT to write a new value to an ES Configuration descriptor in the Lower Tester e.g., *ESP\_WriteRequest* (handle, value).
  2. The Lower Tester sends an *ATT\_Write\_Response* (0x13) to the IUT.

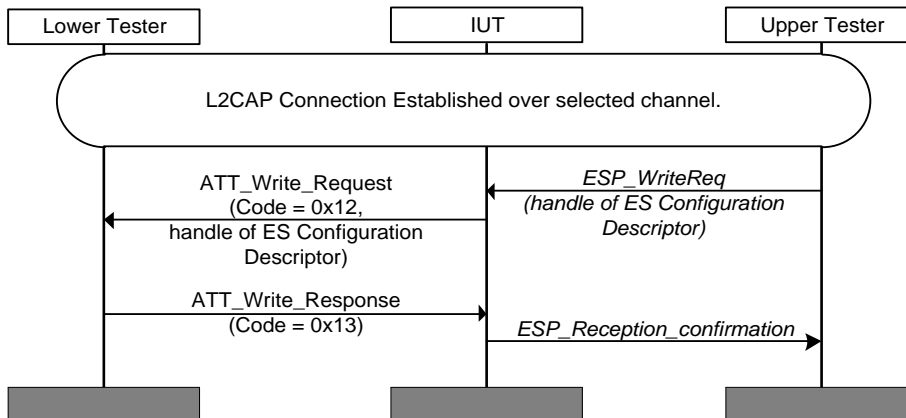

Figure 4.9: ESP/COL/ESW/BV-02-C [Write ES Configuration Descriptor]

- Expected Outcome

Pass verdict

The IUT sends a correctly formatted *ATT\_Write\_Request* (0x12) to the Lower Tester, containing the correct handle and the new value that is to be written as specified by the Upper Tester.

The IUT receives the response from the Lower Tester and sends the *ESP\_WriteResponse* to the Upper Tester.

**ESP/COL/ESW/BV-03-C [Write Characteristic User Description Descriptor]**

- Test Purpose

Verify that the Collector IUT can write the Characteristic User Description descriptor of an ESS Characteristic in an Environmental Sensor when authenticated.

- Reference

[3] 4.4.3

- Initial Condition

- A preamble procedure defined in Section 4.2.3, if using an LE transport, or Section 4.2.4, if using a BR/EDR transport, is used to set up the transport and L2CAP channel and initiate connection to an Environmental Sensor.
- The Upper Tester knows the handle of a Characteristic User Description descriptor contained in the Lower Tester.
- The Collector IUT has been authenticated by the Lower Tester.
- The Characteristic User Description descriptor selected for the test permits writing.
- The length of the Characteristic User Description descriptor value used in this test case is sufficiently short such that its value can be written in its entirety using the GATT Write Characteristic Descriptors sub-procedure when the default ATT\_MTU size is used.

- Test Procedure
  1. Send a command from Upper Tester to request IUT to write the value of the Characteristic User Description descriptor of the ESS Characteristic to the Lower Tester e.g., *ESP\_WriteRequest* (handle, value).
  2. The Lower Tester sends an *ATT\_Write\_Response* (0x13) to the IUT.

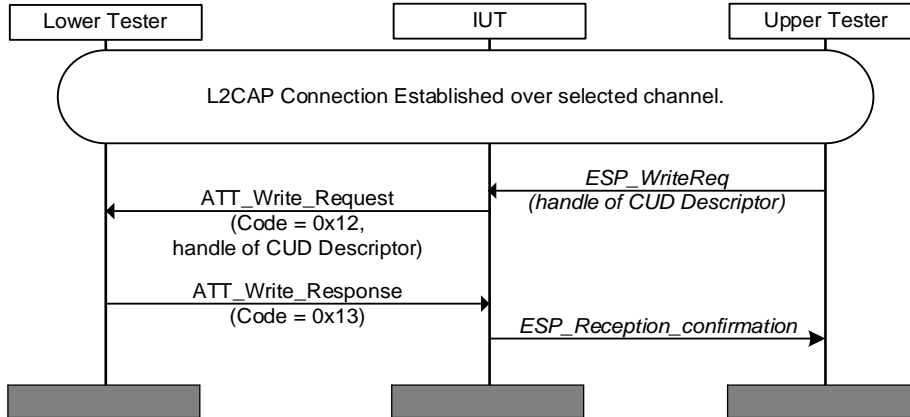

Figure 4.10: ESP/COL/ESW/BV-03-C [Write Characteristic User Description Descriptor]

- Expected Outcome

Pass verdict

The IUT sends a correctly formatted *ATT\_Write\_Request* (0x12) to the Lower Tester, containing the correct handle and the new value that is to be written as specified by the Upper Tester.

The IUT receives the response from the Lower Tester and sends the *ESP\_WriteResponse* to the Upper Tester.

**ESP/COL/ESW/BV-04-C [Write Long Characteristic User Description Descriptor]**

- Test Purpose

Verify that the Collector IUT can write to the Characteristic User Description descriptor(s) of an ESS Characteristic in an Environmental Sensor when the length of the value to be written requires the GATT Write Long procedure to be used.

- Reference

[3] 4.4.3

- Initial Condition

- A preamble procedure defined in Section 4.2.3, if using an LE transport, or Section 4.2.4, if using a BR/EDR transport, is used to set up the transport and L2CAP channel and initiate connection to an Environmental Sensor.
- The Upper Tester knows the handle of an ESS Characteristic and of its Characteristic User Description descriptor contained in the Lower Tester.
- For the purposes of this test case, the Lower Tester does not permit an ATT\_MTU size larger than the default ATT\_MTU size for LE to be negotiated.
- The Collector IUT has been authenticated by the Lower Tester.
- The Characteristic User Description descriptor selected for the test permits writing.

- The length of the characteristic descriptor used in this test case is such that its value is sufficiently long that it cannot be written in its entirety using the GATT Write Characteristic Descriptors sub-procedure when the default ATT\_MTU size is used, requiring the IUT to use the GATT Write Long Characteristic Descriptors sub-procedure.
- The test value to be written to the Characteristic User Description descriptor is a UTF-8 string. The string contains some character values outside the ASCII printable range, if supported by the IUT.
- Test Procedure
  1. Send a command from the Upper Tester to request the IUT to write the test value to the Characteristic User Description descriptor of an ESS Characteristic in the Lower Tester.
  2. The IUT executes the Write Long Characteristic Descriptors sub-procedure.
- Expected Outcome

#### Pass verdict

The IUT sends two or more *ATT\_Prepare\_Write\_Request* commands to the Lower Tester. Each *ATT\_Prepare\_Write\_Request* is correctly formatted and specifies the handle of the correct characteristic descriptor.

After sending all the required *ATT\_Prepare\_Write\_Requests* to write the complete characteristic descriptor value to the Lower Tester, the IUT sends a correctly formatted *ATT\_Execute\_Write\_Request*.

The size of each *ATT\_Prepare\_Write\_Request* does not exceed the ATT\_MTU size.

The Lower Tester receives the expected Characteristic User Description descriptor value, in its entirety, including all the printable and non-printable ASCII values.

## 4.7 Environmental Sensing Features

The procedures defined in this test group verify Environmental Sensing Sensor IUT implementation of the features defined in the Environmental Sensing Profile Specification [3] by an Environmental Sensor IUT, and usage of the same features by a Collector IUT.

### ESP/SEN/ESF/BV-01-C [Environmental Sensing Service UUID in AD]

- Test Purpose
 

Verify that the Environmental Sensing Service UUID is included in AD (Advertising Data) from the Environmental Sensor IUT when using the LE Transport.
- Reference
 

[3] 3.1.1.1
- Initial Condition
  - The IUT is powered on in GAP Discoverable Mode.
  - The IUT is induced to generate Advertising Packets.
- Test Procedure
 

The Lower Tester listens for Advertising Packets from the IUT.

- Expected Outcome

Pass verdict

At least one received Advertising Packet contains the defined Service UUID for «Environmental Sensing Service».

**ESP/SEN/ESF/BV-02-C [Local Name included in AD or Scan Response]**

- Test Purpose

Verify that the Local Name is included in AD (Advertising Data) or Scan Response data from the Environmental Sensor IUT when using the LE Transport.

- Reference

[3] 3.1.1.2

- Initial Condition

- The IUT is powered on in GAP Discoverable Mode.
- The IUT is induced to generate Advertising Packets.

- Test Procedure

1. The Lower Tester listens for Advertising Packets from the IUT.
2. When the Lower Tester receives an Advertising Packet from IUT, it sends a Scan Request to the IUT.
3. The Lower Tester listens for a Scan Response from the IUT.

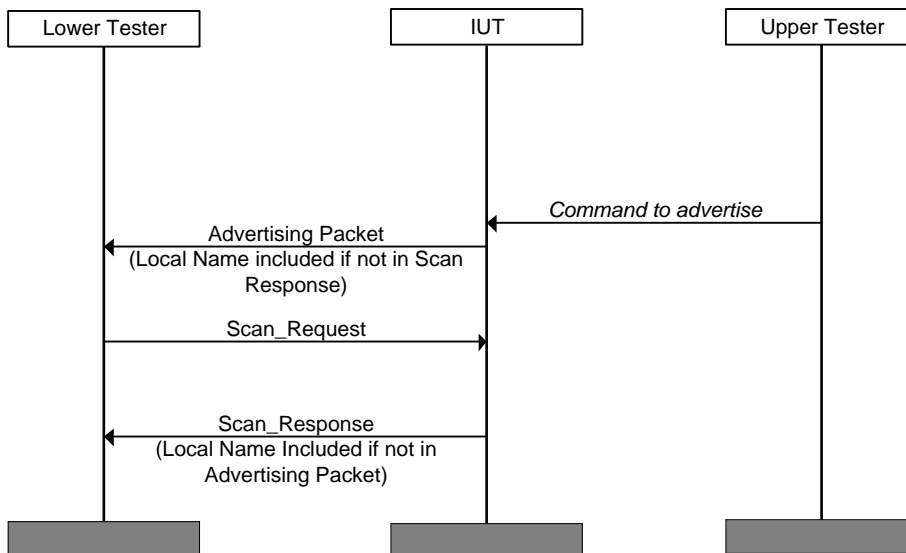

Figure 4.11: ESP/SEN/ESF/BV-02-C [Local Name included in AD or Scan Response]

- Expected Outcome

Pass verdict

The IUT sends an Advertising packet and a Scan Response packet.

The IUT includes the Local Name in either the Advertising packet or Scan Response packet, but not both.

**ESP/SEN/ESF/BV-03-C [Appearance included in AD or Scan Response]**

- Test Purpose
 

Verify that the Appearance characteristic value is included in AD (Advertising Data) or Scan Response data from the Environmental Sensor IUT when using the LE Transport.
- Reference
 

[3] 3.1.1.4
- Initial Condition
  - The IUT is powered on in GAP Discoverable Mode.
  - The IUT is induced to generate Advertising Packets.
- Test Procedure
  1. The Lower Tester listens for Advertising Packets from the IUT.
  2. When the Lower Tester receives an Advertising Packet from IUT, it sends a Scan Request to the IUT.
  3. The Lower Tester listens for a Scan Response from the IUT.

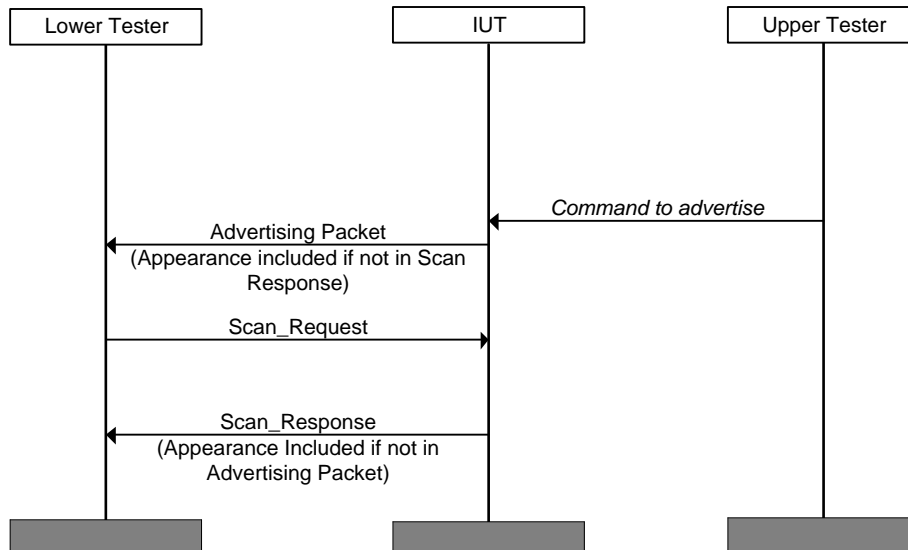

Figure 4.12: ESP/SEN/ESF/BV-03-C [Appearance included in AD or Scan Response]

- Expected Outcome
 

Pass verdict

The IUT sends an Advertising packet and a Scan Response packet.

The IUT includes the Appearance characteristic value in either the Advertising packet or Scan Response packet, but not both.



**ESP/SEN/ESF/BV-04-C [Service Data included in AD]**

- Test Purpose
 

Verify that the Service Data value is included in AD (Advertising Data) from the Environmental Sensor IUT when using the LE Transport.
- Reference
 

[3] 3.1.1.5
- Initial Condition
  - The IUT is powered on in GAP Discoverable Mode.
  - The IUT is induced to generate Advertising Packets.
  - The Environmental Sensor IUT is in a mode in which it will include the Service Data AD Type in its advertising data.
- Test Procedure
  1. The Lower Tester listens for Advertising Packets from the IUT.

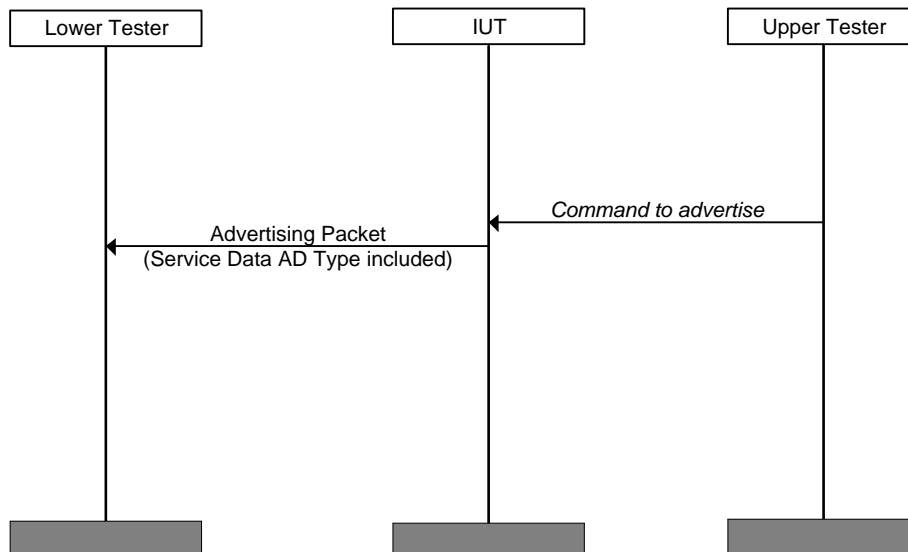

Figure 4.13: ESP/SEN/ESF/BV-04-C [Service Data included in AD]

- Expected Outcome

Pass verdict

The IUT sends an Advertising packet.

The IUT includes the Service Data AD type in the advertising packet with a format meeting the requirements of the service [6].

In addition to the UUID of the Environmental Sensing Service, the Service AD Type value includes two octets containing the Change Index field value as defined in [6].

**ESP/COL/ESF/BV-05-C [Configure ESS Characteristic for Notification]**

- Test Purpose
 

Verify that the Collector IUT can configure an Environmental Sensor (Lower Tester) to notify an ESS Characteristic.
- Reference
 

[3] 4.4
- Initial Condition
  - A preamble procedure defined in Section 4.2.3, if using an LE transport, or Section 4.2.4, if using a BR/EDR transport, is used to set up the transport and L2CAP channel and initiate connection to an Environmental Sensor.
  - The IUT has discovered the Client Characteristic Configuration Descriptor for an ESS Characteristic contained in the Lower Tester.
- Test Procedure
  1. The Upper Tester sends a command to the IUT to configure the Environmental Sensor to send ESS Characteristics.

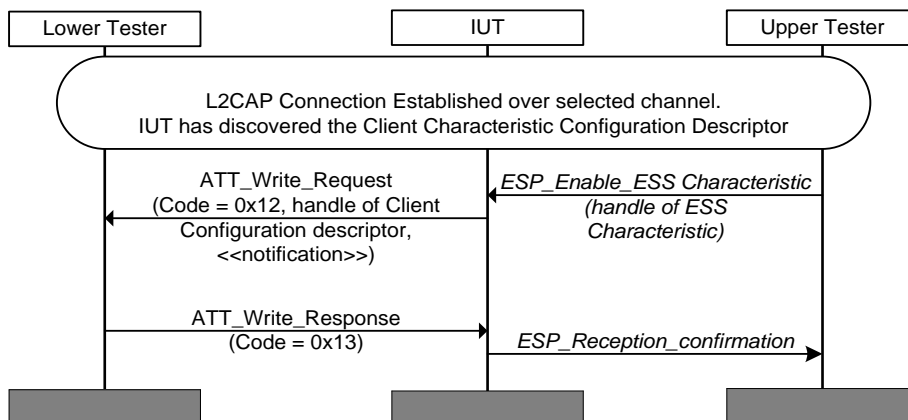

Figure 4.14: ESP/COL/ESF/BV-05-C [Configure ESS Characteristic for Notification]

- Expected Outcome
 

Pass verdict

The IUT sends a correctly formatted *ATT\_Write\_Request* (0x12) to the Lower Tester, with the handle set to that of the Client Characteristic Configuration Descriptor for an ESS Characteristic, and the value set to «notification».

**ESP/COL/ESF/BV-06-C [Receive ESS Characteristic Notifications]**

- Test Purpose
 

Verify that the Collector IUT can receive notifications of the ESS Characteristic.
- Reference
 

[3] 4.4

- Initial Condition
  - A preamble procedure defined in Section 4.2.3, if using an LE transport, or Section 4.2.4, if using a BR/EDR transport, is used to set up the transport and L2CAP channel and initiate connection to an Environmental Sensor.
  - The IUT has executed the procedure included in [ESP/COL/ESF/BV-05-C \[Configure ESS Characteristic for Notification\]](#), which configures it to expect ESS Characteristic Notifications.
  - The IUT knows the handle of the ESS Characteristic.
- Test Procedure
  1. The Lower Tester sends an ATT\_Handle\_Value\_Notification containing an ESS Characteristic value to the IUT.
  2. The Lower Tester sends one ESS Characteristic notification for each ESS Characteristic supported by the IUT.

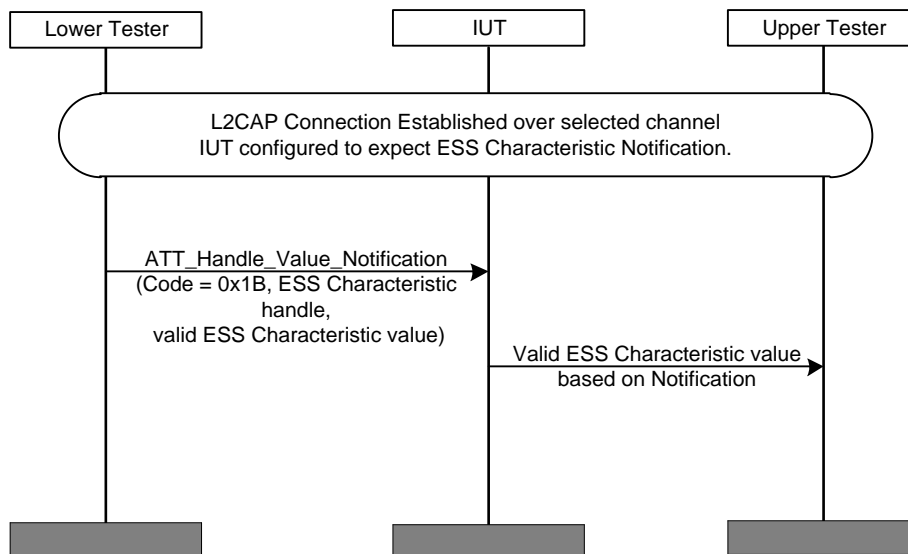

Figure 4.15: ESP/COL/ESF/BV-06-C [Receive ESS Characteristic Notifications]

- Expected Outcome

Pass verdict

The reported ESS Characteristic values match the ones sent by the Lower Tester.

If measurement units (e.g., lb, kg, feet, meters) are provided by the Collector IUT when the values are presented to the user, the units meet the requirements of the service and any scaling factors are correctly applied.

**ESP/COL/ESF/BV-07-C [Configure Descriptor Value Changed for Indication]**

- Test Purpose
 

Verify that the Collector IUT can configure an Environmental Sensor (Lower Tester) to indicate a Descriptor Value Changed indication.

- Reference

[3] 4.5

- Initial Condition
  - A preamble procedure defined in Section 4.2.3, if using an LE transport, or Section 4.2.4, if using a BR/EDR transport, is used to set up the transport and L2CAP channel and initiate connection to an Environmental Sensor.
  - The IUT has discovered the Client Characteristic Configuration Descriptor for the Descriptor Value Changed characteristic contained in the Lower Tester.
- Test Procedure
  1. The Upper Tester sends a command to the IUT to configure the Environmental Sensor to send the Descriptor Value Changed characteristic.
  2. The IUT writes 0x0002 to the Client Characteristic Configuration descriptor of the Descriptor Value Changed characteristic to enable indication.
  3. The Lower Tester sends a Write Response to the IUT to acknowledge the write request sent in step 2.

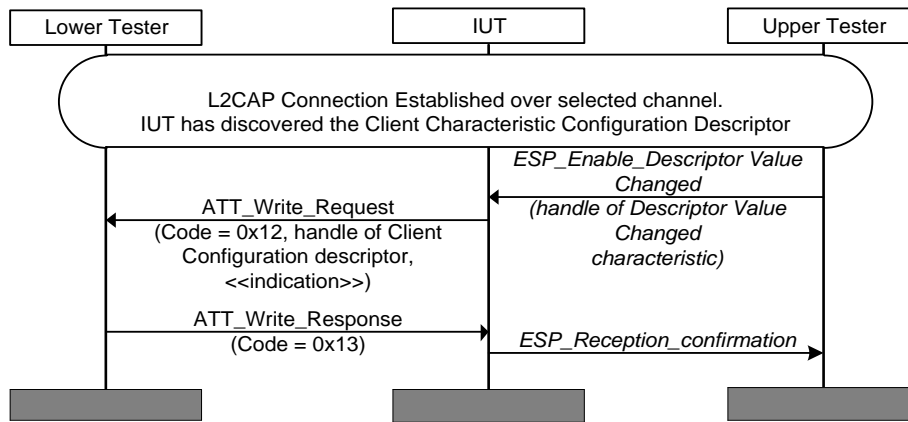

Figure 4.16: ESP/COL/ESF/BV-07-C [Configure Descriptor Value Changed for Indication]

- Expected Outcome
 

Pass verdict

IUT sends a correctly formatted *ATT\_Write\_Request* (0x12) to the Lower Tester, with the handle set to that of the Client Characteristic Configuration Descriptor for the Descriptor Value Changed characteristic and the value set to «indication».

### ESP/COL/ESF/BV-08-C [Receive Descriptor Value Changed Indications]

- Test Purpose
 

Verify that the Collector IUT can receive indications of the Descriptor Value Changed characteristic, including all variants.
- Reference
 

[3] 4.5

- Initial Condition
  - A preamble procedure defined in Section 4.2.3, if using an LE transport, or Section 4.2.4, if using a BR/EDR transport, is used to set up the transport and L2CAP channel and initiate connection to an Environmental Sensor.
  - The IUT has executed the procedure included in [ESP/COL/ESF/BV-07-C \[Configure Descriptor Value Changed for Indication\]](#), which configures it to expect Descriptor Value Changed indications.
  - The IUT knows the handle of the Descriptor Value Changed characteristic.
  - An ESS Characteristic and its associated characteristic descriptors that are supported by the Collector IUT are exposed by the Lower Tester.
- Test Procedure
  1. The Lower Tester sends an ATT\_Handle\_Value\_Indication to the IUT containing a valid Descriptor Value Changed value.
  2. The Lower Tester sends one Descriptor Value Changed indication for each Test Pattern shown in the following table. For each Test Pattern, the value of the Flags field is shown along with the corresponding pass criteria. The value of the Characteristic UUID field is set to that of an ESS Characteristic that is supported by the Collector IUT and exposed by the Lower Tester.

Test Pattern	Flags Field Value (bit15 ... bit0)	Description	Pass Criteria
1	0000 0000 0001 1110	Source of Change is 'Server'. Change to one or more ES Trigger Setting Descriptors; and Change to ES Configuration Descriptor; and Change to ES Measurement Descriptor; and Change to Characteristic User Description Descriptor.	IUT re-reads all the characteristic descriptors that it supports, for the correct ESS Characteristic as specified by the Characteristic UUID field of the Descriptor Value Changed characteristic.
2	0000 0000 0001 0001	Source of Change is 'Client'. Change to Characteristic User Description Descriptor.	IUT re-reads the Characteristic User Description descriptor, if supported, for the correct ESS Characteristic as specified by the Characteristic UUID field of the Descriptor Value Changed characteristic.
3	XXXX XXXX XXX0 1000  At least one bit marked 'X' above is set to 1 – see Description.	Source of Change is 'Server'. Change to ES Measurement Descriptor; and A flag value from the RFU range of the Flags field is set to 1.	IUT re-reads the ES Measurement descriptor for the correct ESS Characteristic as specified by the Characteristic UUID field of the Descriptor Value Changed characteristic.  The flag from the RFU range of the Flags field is ignored by the IUT.

Table 4.3: ESP/COL/ESF/BV-08-C [Receive Descriptor Value Changed Indications]

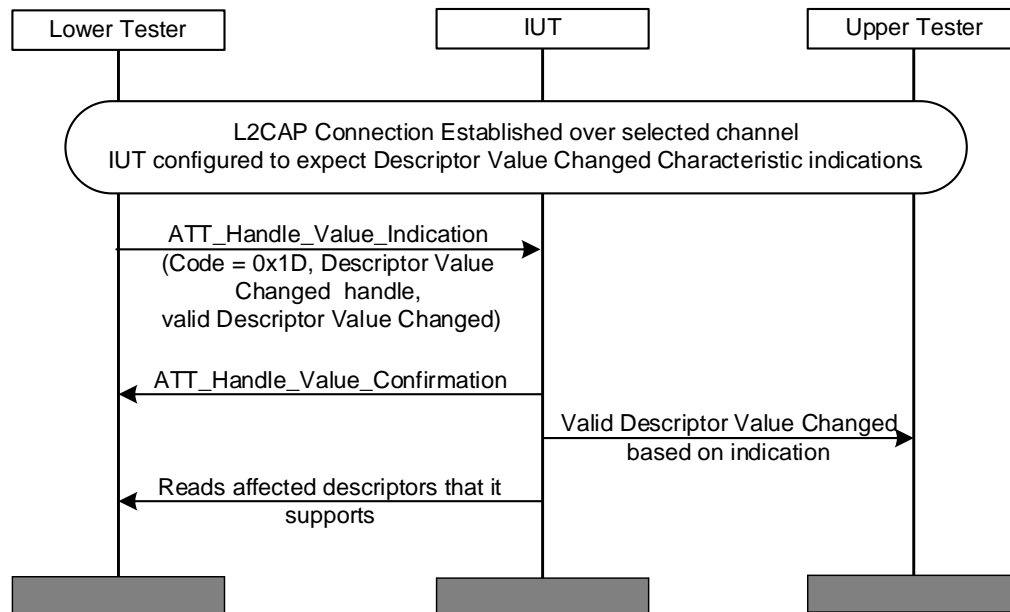

Figure 4.17: ESP/COL/ESF/BV-08-C [Receive Descriptor Value Changed Indications]

- Expected Outcome

Pass verdict

The IUT confirms receipt of each indication by sending a correctly formatted *Handle Value Confirmation* to the Lower Tester.

The IUT reads the affected characteristic descriptors that it supports according to the pass criteria in the table above. The reported bits match the values sent by the Lower Tester.

### ESP/COL/ESF/BV-09-C [Configure a Battery Level Characteristic for Notification]

- Test Purpose

Verify that the Collector IUT can configure an Environmental Sensor (Lower Tester) to notify the Battery Level characteristic.

- Reference

[3] 4.8

- Initial Condition

- A preamble procedure defined in Section 4.2.3, if using an LE transport, or Section 4.2.4, if using a BR/EDR transport, is used to set up the transport and L2CAP channel and initiate connection to an Environmental Sensor.
- The IUT has discovered the Client Characteristic Configuration Descriptor for the Battery Level characteristic contained in the Lower Tester.

- Test Procedure
  1. The Upper Tester sends a command to the IUT to configure the Environmental Sensor to send the Battery Level characteristic.
  2. The IUT writes 0x0001 to the Client Characteristic Configuration descriptor of the Battery Level characteristic to enable notification.
  3. The Lower Tester sends a Write Response to the IUT to acknowledge the write request sent in step 2.

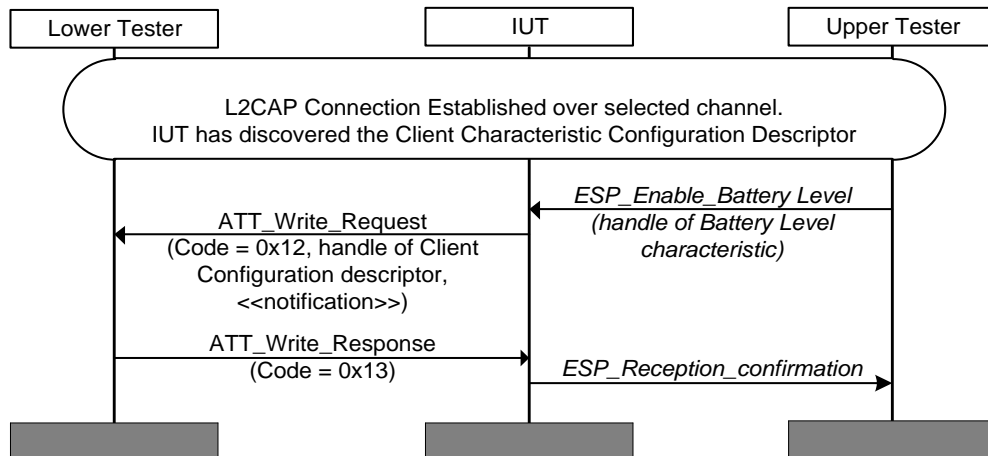

Figure 4.18: ESP/COL/ESF/BV-09-C [Configure a Battery Level Characteristic for Notification]

- Expected Outcome

#### Pass verdict

IUT sends a correctly formatted *ATT\_Write\_Request* (0x12) to the Lower Tester, with the handle set to that of the Client Characteristic Configuration Descriptor for the Battery Level characteristic and the value set to «notification».

### ESP/COL/ESF/BV-10-C [Receive Battery Level Characteristic Notifications]

- Test Purpose

Verify that the Collector IUT can receive notifications of the Battery Level characteristic.

- Reference

[3] 4.8

- Initial Condition

- A preamble procedure defined in Section 4.2.3, if using an LE transport, or Section 4.2.4, if using a BR/EDR transport, is used to set up the transport and L2CAP channel and initiate connection to an Environmental Sensor.
- The IUT has executed the procedure included in [ESP/COL/ESF/BV-09-C \[Configure a Battery Level Characteristic for Notification\]](#), which configures it to expect notifications of the Battery Level characteristic.
- The IUT knows the handle of the Battery Level characteristic.

- Test Procedure
  1. The Lower Tester sends an *ATT\_Handle\_Value\_Notification* containing a Battery Level characteristic value to the IUT.

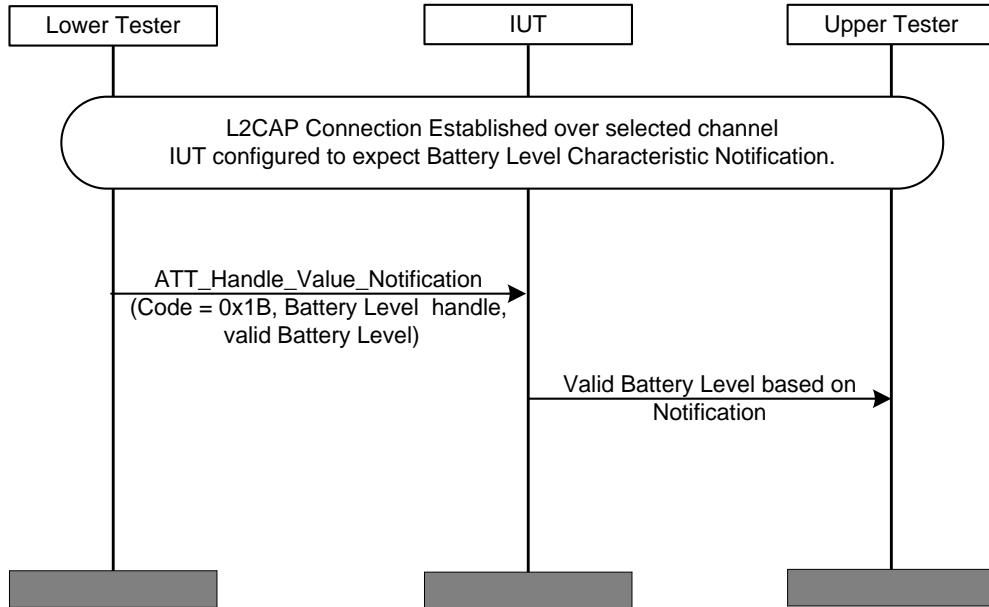

Figure 4.19: ESP/COL/ESF/BV-10-C [Receive Battery Level Characteristic Notifications]

- Expected Outcome

Pass verdict

The IUT correctly receives a Battery Level characteristic notification sent by the Lower Tester.

### ESP/SEN/ESF/BV-11-C [Send ESS Characteristic Notifications – Change Index Update]

- Test Purpose

Verify that the IUT (an Environmental Sensor) updates the value of the Change Index field in the Service Data AD Type included in the advertising data each time a new notification is pending.

- Reference

[3] 3.1.1.5, 5.1.4

- Initial Condition

- Since the IUT is typically a device that measures environmental parameters, this test may require the test setup to be able to control the environmental conditions in order to trigger new measurement values to be notified to the Lower Tester. This may be achieved by using an environmental chamber or by other means.
- The Environmental Sensor IUT is in a mode in which it will include the Service Data AD Type in its advertising data.
- The Lower Tester and the IUT are bonded.



- Test Procedure

The following test procedure is required to be run for only one of the supported ESS Characteristics identified in the ESS ICS [11]:

1. Ensure that the Lower Tester and the IUT are not connected.
2. Perform an action on the IUT that will induce a notification of the ESS Characteristic to be sent with a new measurement value.
3. Verify that the IUT advertises using the Service Data AD Type in the Advertising Packet.
4. Record the value of the Change Index included in the Service Data AD Type.
5. The Lower Tester attempts to connect to the IUT.
6. Verify that a connection is established with the Lower Tester and a notification of the ESS Characteristic is sent by the IUT.
7. The Lower Tester disconnects from IUT.
8. Repeat steps 1–3.
9. The Lower Tester records the value of the Change Index included in the Service Data AD Type in the advertising data of the IUT.
10. Repeat steps 1–3.
11. The Lower Tester records the value of the Change Index included in the Service Data AD Type in the advertising data of the IUT.

- Expected Outcome

Pass verdict

The Change Index Field contains a different value in step 4, step 9, and step 11.

A notification of the expected ESS Characteristic is sent by the IUT in step 6.

### ESP/COL/ESF/BV-12-C [Receive ESS Characteristic Notifications – Change Index Filtering]

- Test Purpose

Verify that the IUT (a Collector) can properly filter based on the value of the Change Index field of the Service Data AD Type.

The following test procedure is required to be run on only one of the supported notifiable ESS Characteristics supported by the IUT.

- Reference

[3] 3.1.1.5, 5.2.2

- Initial Condition

- The IUT has executed the procedure included in [ESP/COL/ESF/BV-05-C \[Configure ESS Characteristic for Notification\]](#), which configures it to expect ESS Characteristic Notifications.
- The client characteristic configuration descriptor of at least one ESS Characteristic is configured for notification.
- The IUT knows the handle of the ESS Characteristic.
- The IUT and the Lower Tester are bonded.

- Test Procedure
  1. Ensure that the Lower Tester and the IUT are not connected.
  2. The Lower Tester advertises using the Service Data AD Type in the Advertising Packet. The value of the Change Index field is set to a pseudo-random value.
  3. The IUT connects to the Lower Tester.
  4. The Lower Tester sends a notification of the ESS Characteristic to the IUT.
  5. The IUT receives the notification of the ESS Characteristic.
  6. The Lower Tester and the IUT disconnect.
  7. The Lower Tester advertises again using the Service Data AD Type in the Advertising Packet. The value of the Change Index field is set to a new pseudo-random value.
  8. The IUT attempts to connect to the Lower Tester and the Lower Tester rejects the connection.
  9. The Lower Tester continues to advertise using the Service Data AD Type in the Advertising Packet with the same Change Index field value as in step 7.
  10. Verify that the IUT does not attempt to connect to the Lower Tester.
  11. The Lower Tester advertises using the Service Data AD Type in the Advertising Packet with a new pseudo-random value (not the same as in step 2 or step 7) in the Change Index field.
  12. The IUT connects to the Lower Tester.
  13. The Lower Tester sends a notification of the ESS Characteristic to the IUT.
  14. The IUT receives the notification of the ESS Characteristic.

- Expected Outcome

#### Pass verdict

In step 3, verify that the IUT connects to retrieve the notification.

In step 8, verify that the IUT attempts to connect to the Lower Tester before being rejected.

In step 10, verify that the IUT does not attempt to connect to the Lower Tester.

In step 12, verify that the IUT connects to retrieve the notification.

## 4.8 Service Procedures – General Error Handling

This test group contains test cases to verify compliant operation when an error is caused by the Server side.

### ESP/COL/SPE/BI-01-C [Application Error Handling – Condition Not Supported]

- Test Purpose

Verify that the Collector IUT can handle receipt of an ATT Application Error defined in [6] when it attempts to write a value to the Lower Tester.

- Reference

[3] 4.4.2, 4.6

- Initial Condition

- A preamble procedure defined in Section 4.2.3, if using an LE transport, or Section 4.2.4, if using a BR/EDR transport, is used to set up the transport and L2CAP channel and initiate connection to an Environmental Sensor.
- The Collector IUT and the Lower Tester are bonded.



- The Upper Tester knows the handle of an ESS Characteristic and of its ES Trigger Setting descriptor(s) contained in the Lower Tester.
- The ES Trigger Setting descriptor selected for the test permits writing.
- Test Procedure
  1. Send a command from the Upper Tester to request the IUT to write a new value to an ES Trigger Setting descriptor in the Lower Tester e.g., *ESP\_WriteRequest* (handle, value).
  2. The Lower Tester sends an *ATT\_Application\_Error* (0x81) to the IUT.

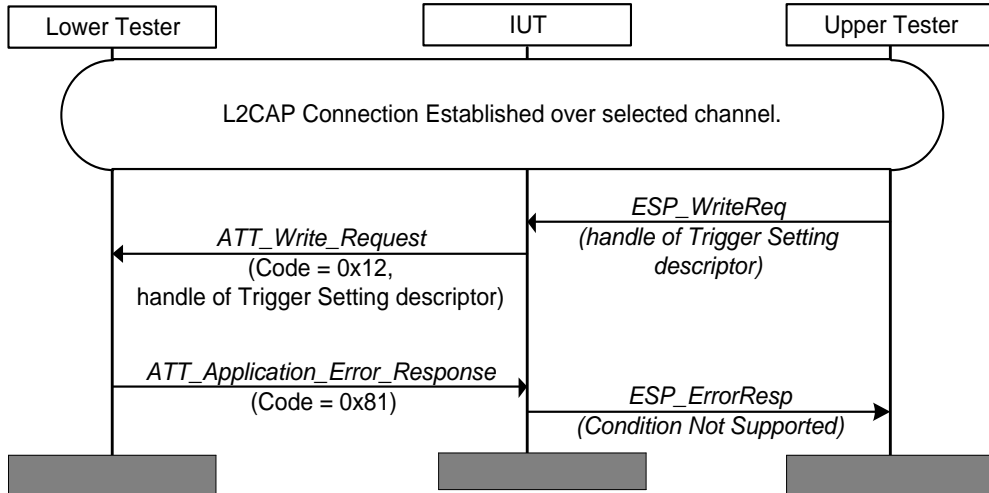

Figure 4.20: ESP/COL/SPE/BI-01-C [Application Error Handling – Condition Not Supported]

- Expected Outcome

Pass verdict

The IUT sends a correctly formatted *ATT\_Write\_Request* (0x12) to the Lower Tester, containing the correct handle and the new value that is to be written as specified by the Upper Tester.

The IUT receives the *Condition Not Supported* (0x81) ATT Application Error response from the Lower Tester and sends the *ESP\_ErrorResponse* to the Upper Tester.

The IUT returns to a stable state and can process commands normally.

## 5 Test case mapping

The Test Case Mapping Table (TCMT) maps test cases to specific requirements in the ICS. The IUT is tested in all roles for which support is declared in the ICS document.

The columns for the TCMT are defined as follows:

**Item:** Contains a logical expression based on specific entries from the associated ICS document. Contains a logical expression (using the operators AND, OR, NOT as needed) based on specific entries from the applicable ICS document(s). The entries are in the form of y/x references, where y corresponds to the table number and x corresponds to the feature number as defined in the ICS document for the Environmental Sensing Profile [4].

**Feature:** A brief, informal description of the feature being tested.

**Test Case(s):** The applicable test case identifiers are required for Bluetooth Qualification if the corresponding y/x references defined in the Item column are supported. Further details about the function of the TCMT are elaborated in [1].

For the purpose and structure of the ICS/IXIT, refer to [1].

Item	Feature	Test Case(s)
ESP 7/1	Discover Environmental Sensing Service	ESP/COL/CGGIT/SER/BV-01-C
ESP 7/2	Discover Device Information Service and characteristics	ESP/COL/CGGIT/SER/BV-02-C ESP/COL/ESD/BV-10-C ESP/COL/ESR/BV-08-C
ESP 7/3	Discover Battery Service and characteristics	ESP/COL/CGGIT/SER/BV-03-C ESP/COL/CGGIT/CHA/BV-02-C
ESP 2/1 AND GAP 0/3 AND ESP 3/2 AND NOT ESP 3/1 AND GATT 1a/4	Discover Environmental Sensing Service – Not Discoverable over BR/EDR	ESP/SEN/SGGIT/SDPNF/BV-01-C
ESP 2/2	Mandatory Collector tests	ESP/COL/ESD/BV-06-C ESP/COL/ESD/BV-07-C
ESP 8/7	Discover Descriptor Value Changed Characteristic	ESP/COL/CGGIT/CHA/BV-01-C
ESP 12/1	Read ESS Characteristic	ESP/COL/ESR/BV-01-C
ESP 12/2	Read ES Measurement Descriptor	ESP/COL/ESR/BV-02-C
ESP 12/3	Read ES Trigger Setting Descriptor	ESP/COL/ESR/BV-03-C
ESP 12/6	Read ES Configuration Descriptor	ESP/COL/ESR/BV-04-C
ESP 12/8	Read and Read Long Characteristic User Description Descriptor	ESP/COL/ESR/BV-05-C ESP/COL/ESR/BV-06-C
ESP 12/11	Read Valid Range Descriptor	ESP/COL/ESR/BV-07-C
ESP 12/4	Write ES Trigger Setting Descriptor	ESP/COL/ESW/BV-01-C ESP/COL/SPE/BI-01-C
ESP 12/7	Write ES Configuration Descriptor	ESP/COL/ESW/BV-02-C
ESP 12/10	Write and Write Long Characteristic User Description Descriptor	ESP/COL/ESW/BV-03-C ESP/COL/ESW/BV-04-C

Item	Feature	Test Case(s)
ESP 4/2	Environmental Sensing Service UUID in AD	ESP/SEN/ESF/BV-01-C
ESP 4/3	Local Name in AD or Scan Response	ESP/SEN/ESF/BV-02-C
ESP 4/4	Appearance in AD or Scan Response	ESP/SEN/ESF/BV-03-C
ESP 4/5	Service Data included in AD	ESP/SEN/ESF/BV-04-C
ESP 12/8	ESS Characteristic Notifications	ESP/COL/ESF/BV-05-C ESP/COL/ESF/BV-06-C
ESP 12/12	Descriptor Value Changed Characteristic Indications	ESP/COL/ESF/BV-07-C ESP/COL/ESF/BV-08-C
ESP 9/2	Receive Battery Level Characteristic Notifications	ESP/COL/ESF/BV-09-C ESP/COL/ESF/BV-10-C
ESP 4/5	Send ESS Notifications – Change Index Update	ESP/SEN/ESF/BV-11-C
ESP 10/1 AND ESP 12/4 AND ESP 12/8	Receive ESS Characteristic Notifications – Filter using Change Index	ESP/COL/ESF/BV-12-C

Table 5.1: Test case mapping

## 6 Revision history and acknowledgments

### Revision History

Publication Number	Revision Number	Date	Comments
0	1.0.0	2014-11-25	Prepare for Publication
	1.0.1r00	2015-05-10	TSE 6160: Corrected TCMT mapping for ESP/SEN/ESD/BV-05-I (legacy ID: TP/ESD/ES/BV-05-I) by adding GAP 0/3.
1	1.0.1	2015-07-14	Prepared for TCRL 2015-1 publication
	1.0.2r00	2016-05-24	Converted to new Test Case ID conventions as defined in TSTO v4.1.
2	1.0.2	2016-07-14	Prepared for TCRL 2016-1 publication.
	1.0.3r00	2017-10-02	TSE 9918 (rating 1): Update test specification template and conventions.
3	1.0.3	2018-06-27	Approved by BTI. Prepared for TCRL 2018-1 publication.
	1.0.3 edition 2r00	2020-02-14	TSE 12988 (rating 1): Changed “0x1A” to “0x1D” in MSC for test case ESP/COL/ESF/BV-08-I. Minor editorials, including updating template/styles to current conventions.
	1.0.3 edition 2r01	2020-05-19	Additional editorials and template updates.
	1.0.3 edition 2	2020-06-01	Performed minor formatting and template updates, rolled back document numbering to reflect an edition release, and accepted all tracked changes. Approved by BTI on 2020-06-01. Prepared for edition 2 publication.
	p4r00–r07	2022-03-18 – 2022-05-19	<p>TSE 17259 (rating 2): Converted the following test cases to GGIT: ESP/COL/ESD/BV-01-I – -04-I, -08-I, 09-I, and -11-I; ESP/SEN/ESD/BV-05-I; and ESP/COL/ESR/BV-09-I. The new GGIT converted TCIDs are: ESP/COL/CGGIT/SER/BV-01-C – -03-C, ESP/COL/CGGIT/CHA/BV-01-C and -02-C, and ESP/SEN/SGGIT/SDPNF/BV-01-C. Updated the TCMT accordingly. Updated the initial condition section for ESP/COL/ESD/BV-06-I and -10-I. Inserted a test database requirements section. Updated test groups and test case identification conventions section.</p> <p>TSE 18432 (rating 2): Removed direct references to GATT test cases from the test procedures for ESP/COL/ESD/BV-06-I, -07-I, and -10-I; ESP/COL/ESR/BV-06-I, -08-I; and ESP/COL/ESW/BV-04-I. Removed direct references to GATT TS sections from the ATT Bearer preambles and replaced with preamble procedure text.</p> <p>TSE 18716 (rating 1): Editorials to align the document with the latest TS template in anticipation of a future .Z release.</p>

Publication Number	Revision Number	Date	Comments
			Editorials, including aligning the copyright page with v2 of the DNMD, adding captions to figures, and making consistency checker updates.
4	p4	2022-06-28	Approved by BTI on 2022-05-31. Prepared for TCRL 2022-1 publication.
	p5r00	2023-10-21	TSE 23269 (rating 1): Converted -I tests to -C tests as appropriate; updated the TCMT and TCRL accordingly. Deleted draft revision history comments prior to p0.
5	p5	2024-07-01	Approved by BTI on 2024-04-21. Prepared for TCRL 2024-1 publication.
	p6r00	2024-07-31	TSE 18590 (rating 1): Per E15786, updated for appropriate language.
6	p6	2024-10-08	Approved by BTI on 2024-09-11. ESP v1.0.1 adopted by the BoD on 2024-10-01. Prepared for TCRL 2024-2-addition publication.

### **Acknowledgments**

Name	Company
Dejan Berec	Bluetooth SIG, Inc.
Jawid Mirani	Bluetooth SIG, Inc.
Laurence Richardson	Cambridge Silicon Radio
Tatsuo Aria	Casio
Robert D. Hughes	Intel